

Dart

Dart

Bonding line Aa

Bonding line AA

Bonding line AA



Bonding line Ba

Bonding line AB

Bonding line AB

Seam allowance 1in.

Bonding line AC

Bonding line Ca

Bonding line AC

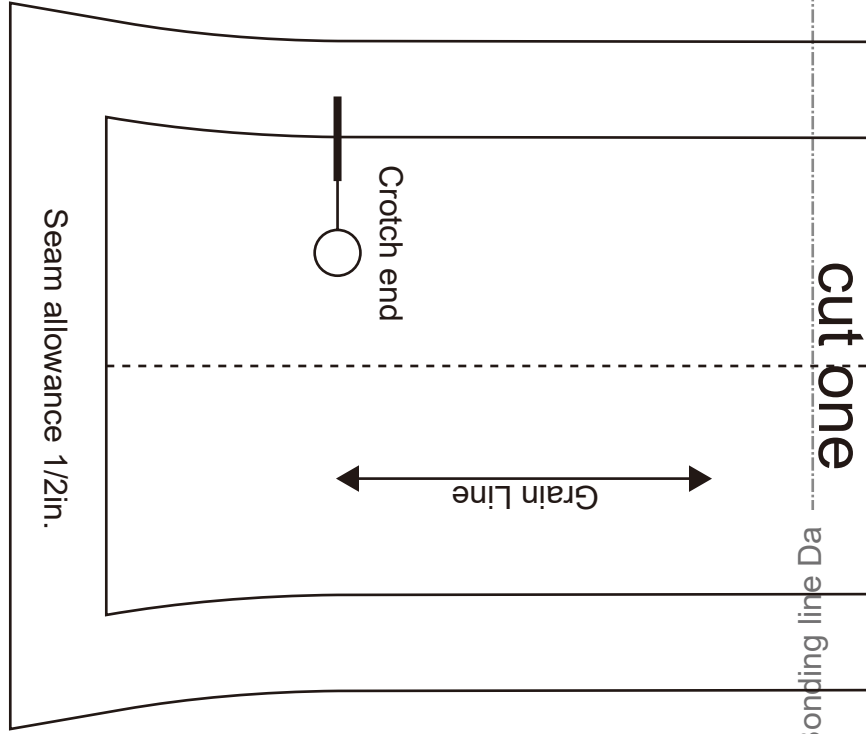

cut one

Bonding line Da

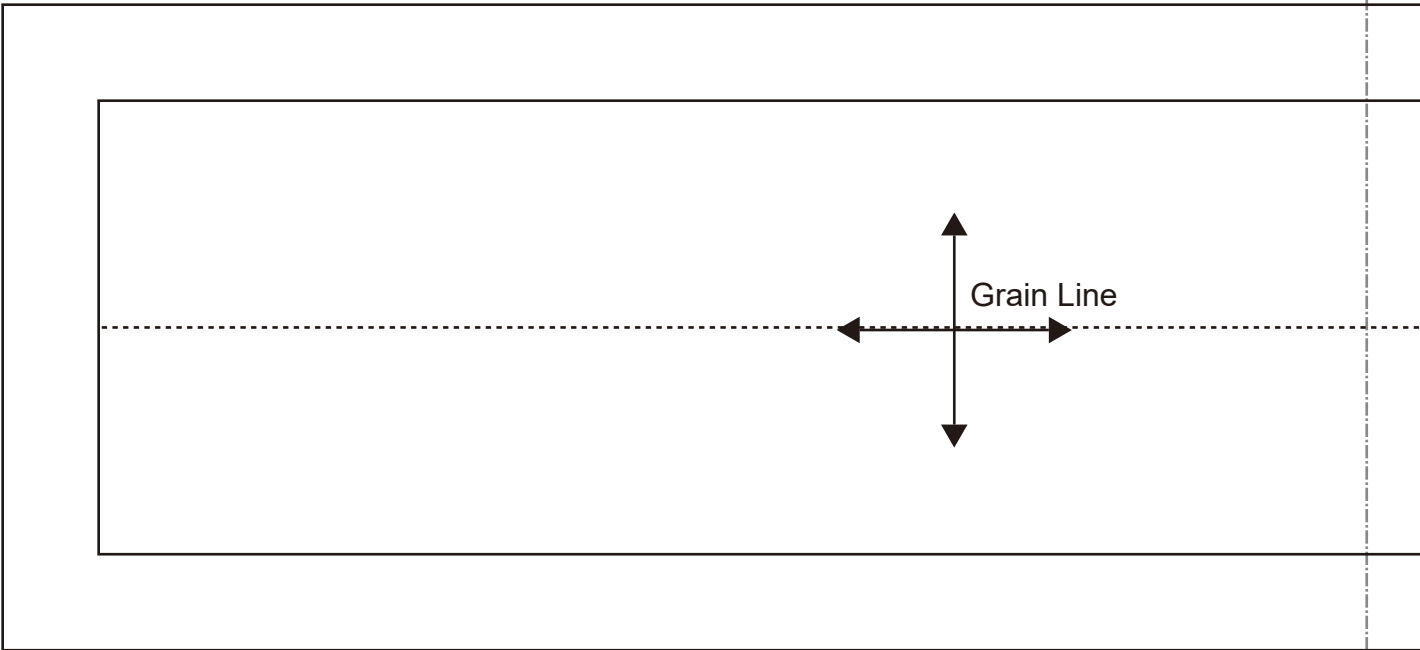

Bonding line AD

Bonding line Aa

Bonding line Ab

Bonding line BA

Bonding line BA

Crotch end



Bonding line Ba

Bonding line Bb

Bonding line BB

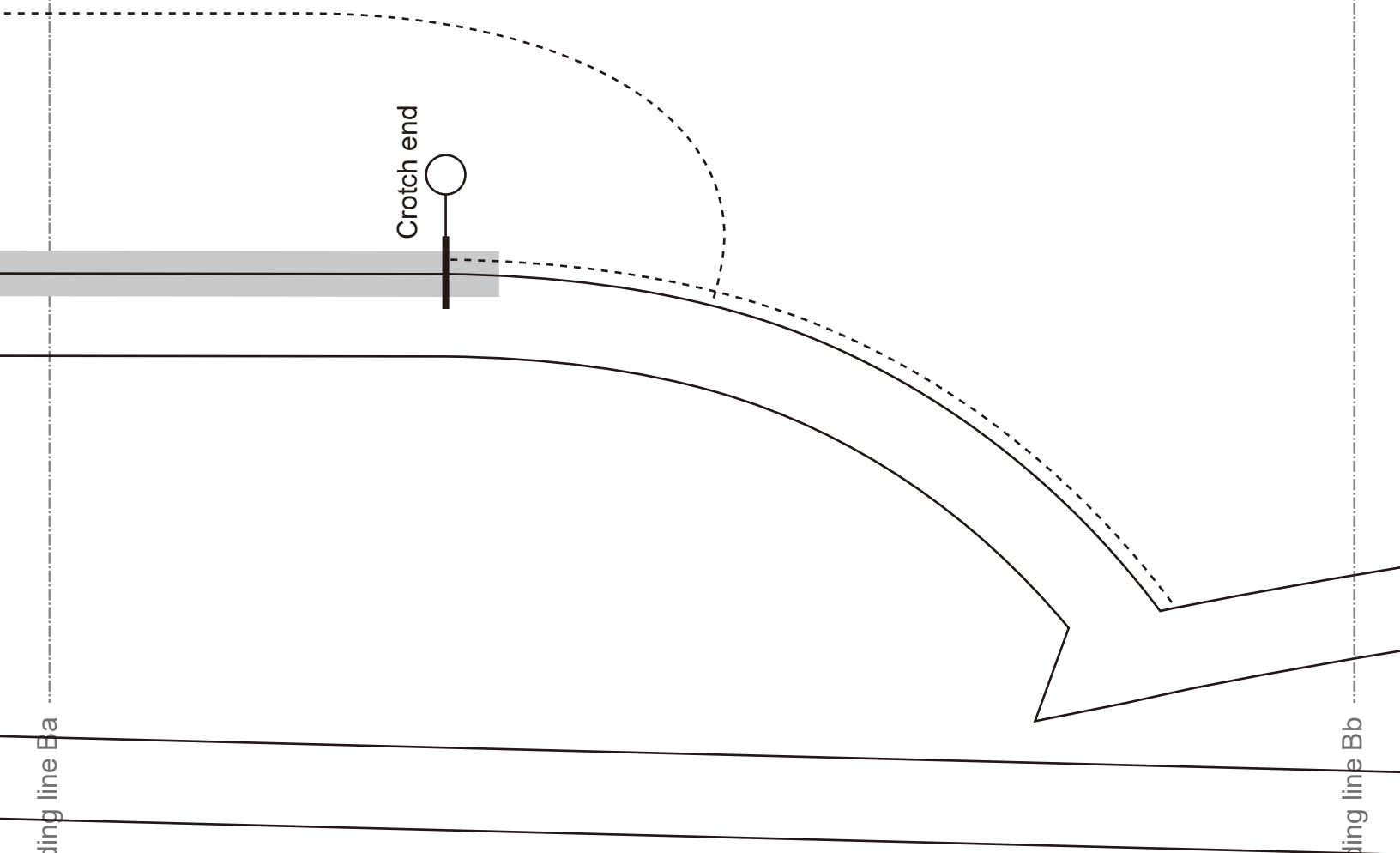

Bonding line BB

Bonding line Ca

Bonding line Cb

Bonding line BC

Bonding line BC

Bonding line Da

Bonding line Db

Bonding line BD

# MEN'S

## DRCOS

SITE <https://drcos.info/en> | <https://drcos.com/jp>  
MAIL [info@drcos.com](mailto:info@drcos.com)  
Twitter [https://twitter.com/drcos\\_com](https://twitter.com/drcos_com)  
Pinterest <https://www.pinterest.jp/drcosinfo>

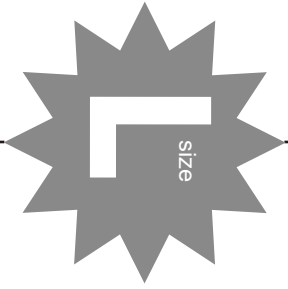

size

**Widepants**  
**Fly extension**  
**Interfacing**  
**cut one**



Bonding line Ab

**MEN'S** size **L**

**Widepants  
Front Bodice  
cut two**

Bonding line CA

Seam

Bonding line Ac



Bonding line CA

Bonding line Bb

Bonding line Bc

Seam allowance 1/2in.

Bonding line CB

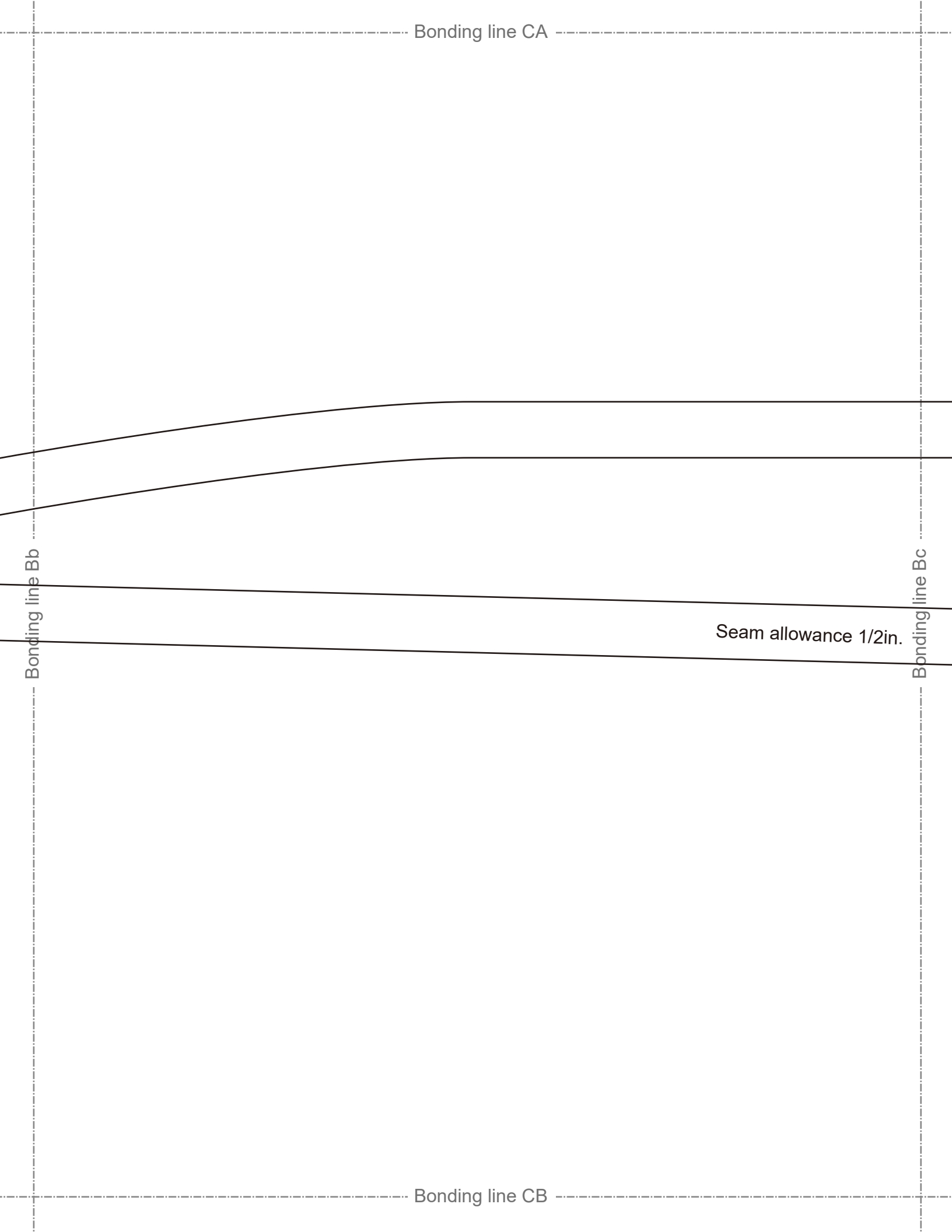

Bonding line CB

Bonding line Cb

Bonding line Cc

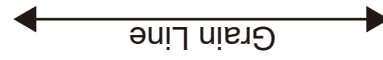

Bonding line CC

Bonding line CC

Bonding line Db

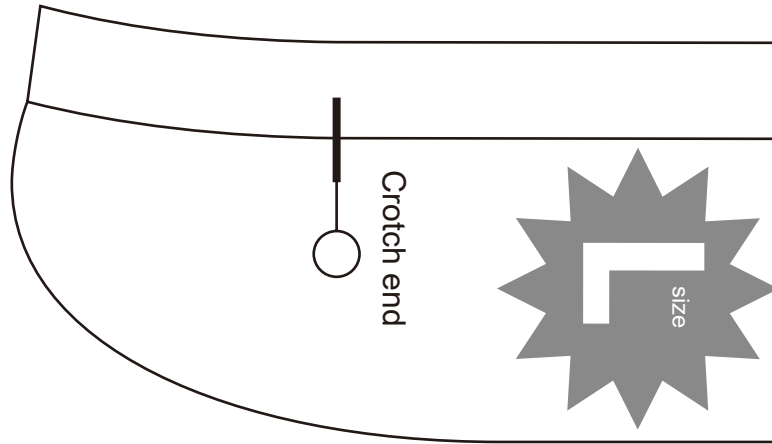

Seam allowance

Widepants Facing Interfacing cut one

Bonding line Dc

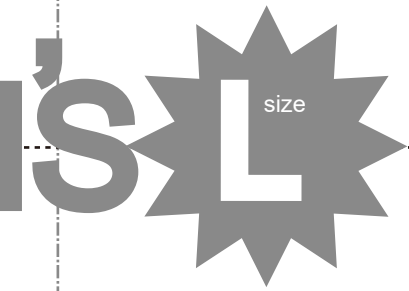

Seam allowance 1/2in.

Bonding line CD

V  
W  
T

Seam allowance 1/2in.

Bonding line Ac

Bonding line Ad

Grain Line

Bonding line DA

Bonding line DA

Bonding line Bc

Bonding line Bd

n.

Bonding line DB

Bonding line DB



**Widepants**  
**Back Bodice**  
**cut two**

Bonding line Cc

Bonding line Cd

Bonding line DC

Bonding line DC

allowance 1/2in.

nts  
g  
ing  
e

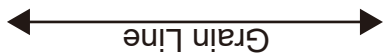

**DRCOS**

SITE [https://dr-cos.info\(en\)](https://dr-cos.info(en)) [https://dr-cos.com\(jp\)](https://dr-cos.com(jp))  
MAIL [info@dr-cos.com](mailto:info@dr-cos.com)  
Twitter [@drcos\\_com](https://twitter.com/@drcos_com)  
pinterest <https://www.pinterest.jp/drcosinfo>

Bonding line Dc

Bonding line Dd

Widepants  
Waist Band  
Interfacing  
cut one

Bonding line DD



Bonding line Ad

Bonding line Ae

Bonding line EA

Bonding line EA

Bonding line Bd

Bonding line Be

Bonding line EB

Baste



Bonding line EB

Bonding line Cd

Bonding line Ce

Sew double-stitch

Bonding line EC



Bonding line EC

Bonding line Dd

Bonding line De



extension

Bonding line ED

Bonding line Ae

Bonding line FA



Seam allowance 1in.

Bonding line Af

Bonding line FA

Bonding line Be

Bonding line Bf

Bonding line FB

Dart

