

Bonding line AA

Children's

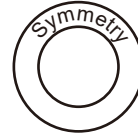

Tucked Skirt
Front body
one sheets



Bonding line Ba

Bonding line AB

Bonding line AB

17.3in length cut line

18.9in length cut line

20.5in length cut line

22in length cut line

Bonding line Ca

Seam allow

Bonding line AC

Tucked Skirt Belt

one sheets
Fusible interlining
one sheets

Seam allowance

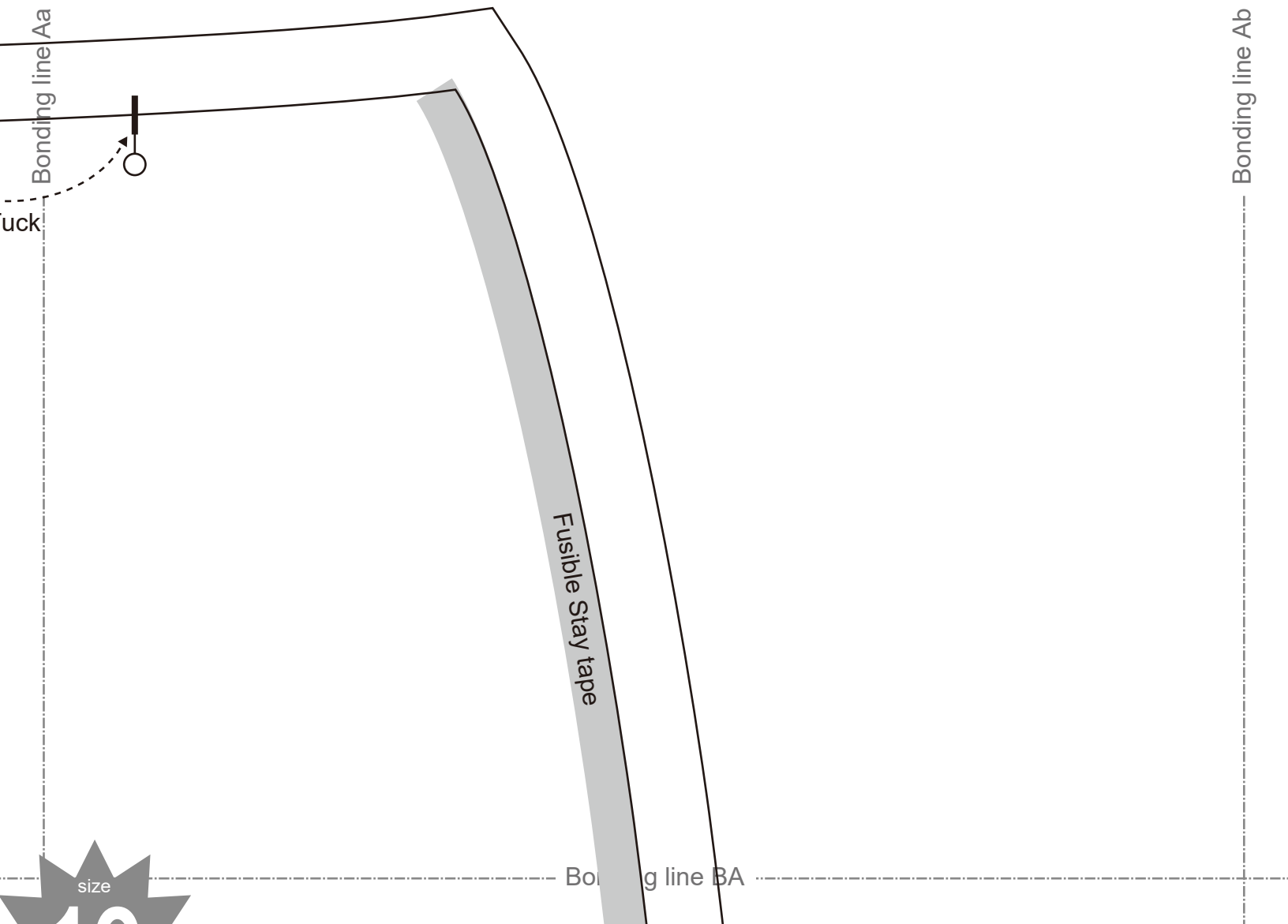
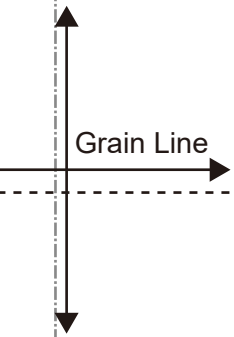

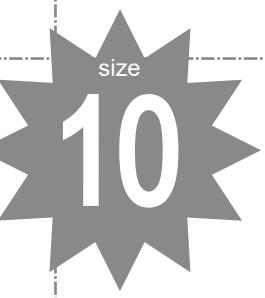

Bonding line BA

Fastener end



Seam allowance 1/2in.

Bonding line BB

Bonding line Ba

Bonding line Bb

Bonding line BB



DRCOS
SITE [http://dr-cos.info\(en\)](http://dr-cos.info(en)) [http://dr-cos.com\(jp\)](http://dr-cos.com(jp))
MAIL info@dr-cos.com
Twitter [@drcos_com](https://twitter.com/@drcos_com)
facebook <https://www.facebook.com/drcoscom>

Bonding line Ca

Bonding line Cb

m allowance 1in.

Bonding line BC

Bonding line CA

Children's

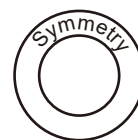

Tucked Skirt
Back body
one sheets



Bonding line Bb

Bonding line Bc

Bonding line CB

Bonding line CB

Bonding line Cb

Bonding line Cc

Bonding line CC

Seam allowan

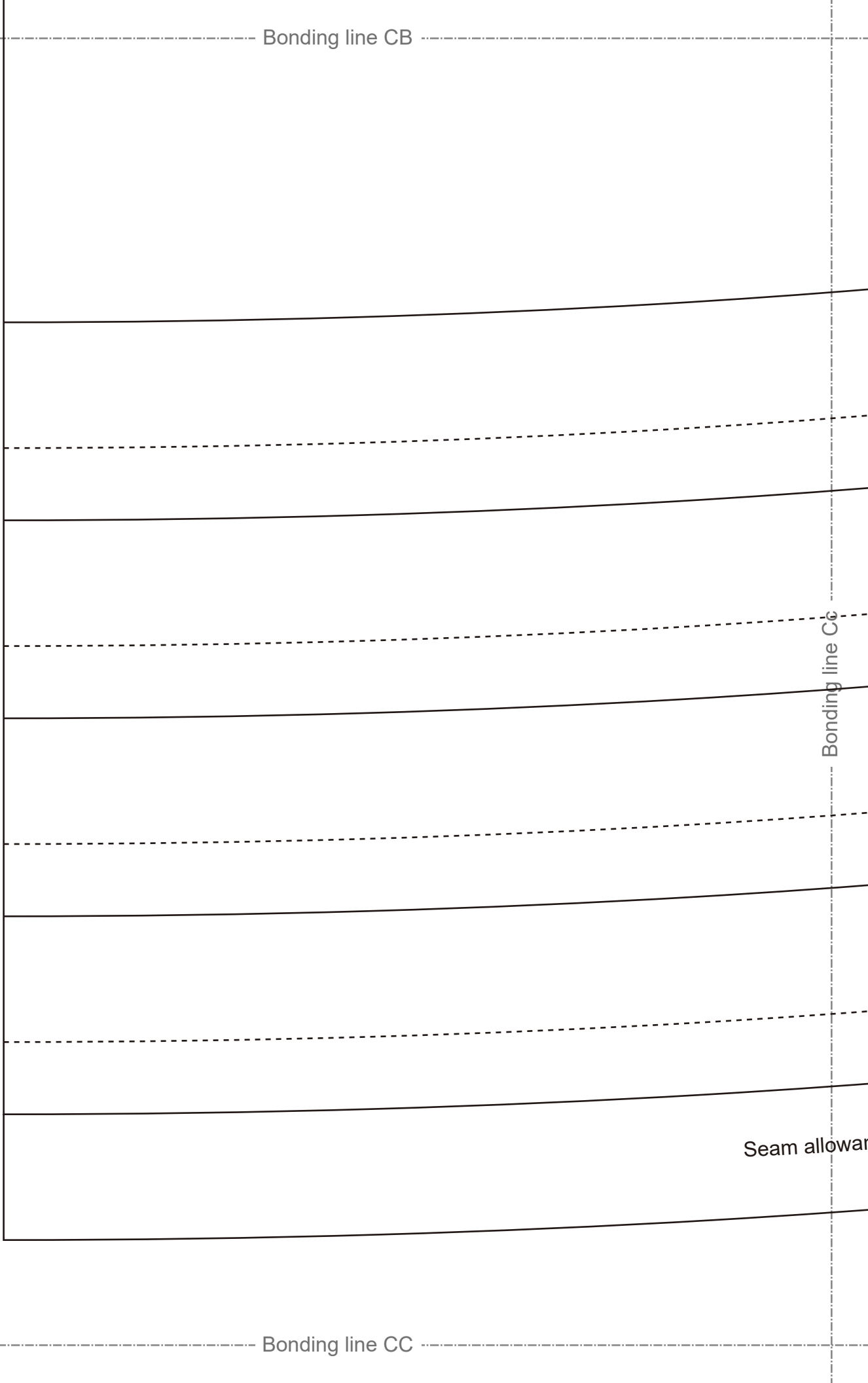

DRCOS

SITE <http://dr-cos.info/en> <http://dr-cos.com/jp>
MAIL info@dr-cos.com
Twitter https://twitter.com/drcos_com
facebook <https://www.facebook.com/drcoscom>

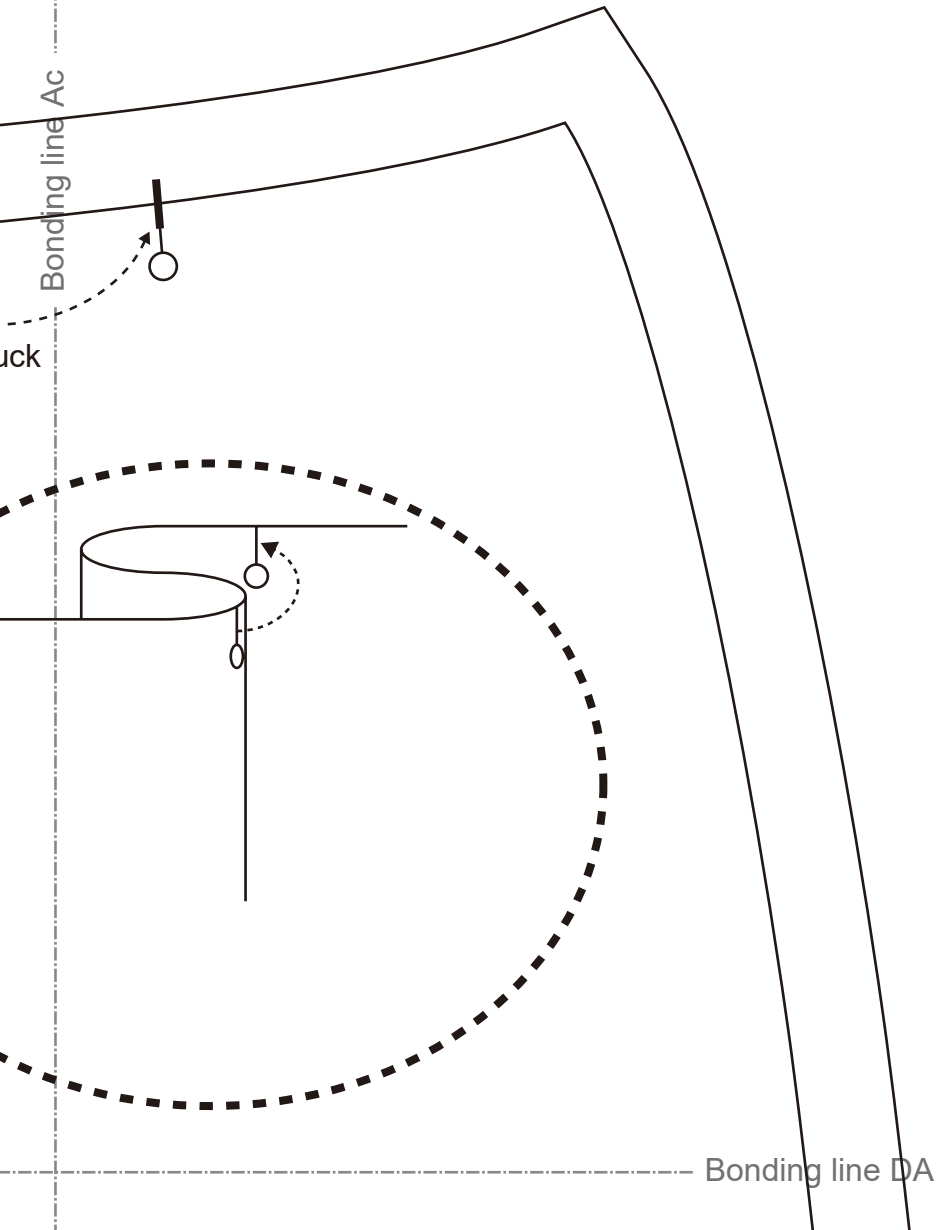

Bonding line Ad

S

skirt
y
ts

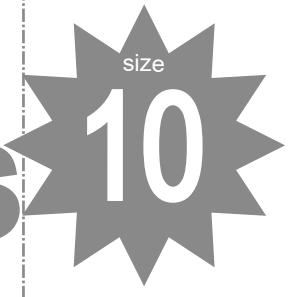

Bonding line Bc

Bonding line DA

Seam allowance 1/2in.

Bonding line Bd

Bonding line DB

Bonding line DB



DRCOS
SITE [http://dr-cos.info\(en\)](http://dr-cos.info(en)) [http://dr-cos.com\(jp\)](http://dr-cos.com(jp))
MAIL info@dr-cos.com
Twitter https://twitter.com/@drcos_com
facebook <https://www.facebook.com/drcoscom>

Bonding line Cc

Bonding line Cd

allowance 1in.

Bonding line DC