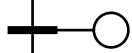

[Home](#)

[Back to Tshirt7 page](#)

STF <http://dr-cos.info/en> <http://dr-cos.com/fp>  
MAIL [info@dr-cos.com](mailto:info@dr-cos.com)  
Twitter [https://twitter.com/dr-cos\\_com](https://twitter.com/dr-cos_com)  
facebook <https://www.facebook.com/drcoscom>

**DRCOS**

Slit position 

Bonding line AA

Bonding line Aa

Bonding line AA

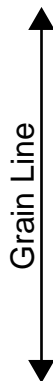

Grain Line

Bonding line Ba

Seam allowance 1/2in.



Tshirt  
Front Body  
one sheets



Bonding line AB

T-shirt

Bonding line AB

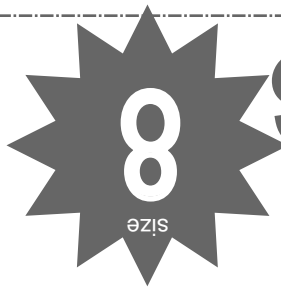

# Children's

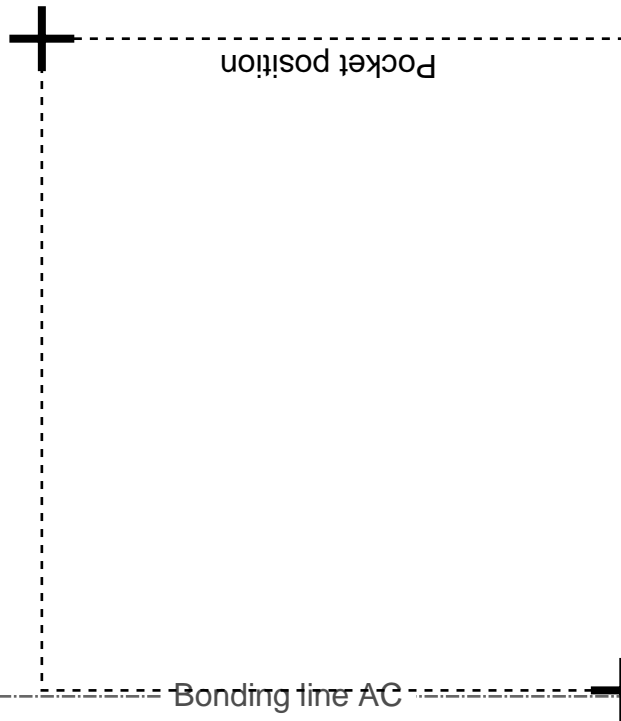

Bonding line AC

Bonding line Ca

Bonding line AC



**DRCOS**  
SITE <http://dr-cos.info/en> <http://dr-cos.com/jp>  
MAIL [info@dr-cos.com](mailto:info@dr-cos.com)  
Twitter [@drcos\\_com](https://twitter.com/@drcos_com)  
facebook <https://www.facebook.com/drcoscom>

Bonding line Da

# Children's

Front

Grain Line

Tshirt7  
Sleeve  
two sheets

Seam allowance 1/2in.

Bonding line AD

Bonding line Aa

Bonding line Ab

Bonding line BA

**DRCOS**  
SITE [http://dr-cos.info\(en\)](http://dr-cos.info/en) [http://dr-cos.com\(jp\)](http://dr-cos.com(jp))  
MAIL [info@dr-cos.com](mailto:info@dr-cos.com)  
Twitter [https://twitter.com/dr-cos\\_com](https://twitter.com/dr-cos_com)  
facebook <https://www.facebook.com/drcoscom>

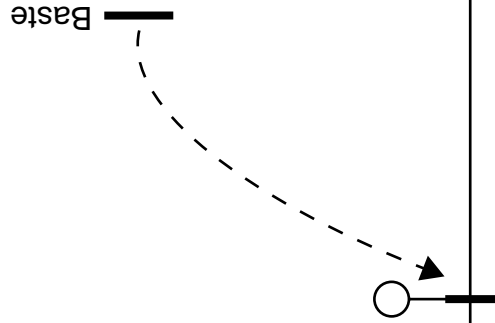

Bonding line Ba

Bonding line BA

Grain Line

Seam allowance 1/2in.

Bonding line Bb



Tshirt  
Back Body  
one sheets

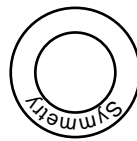

Bonding line BB



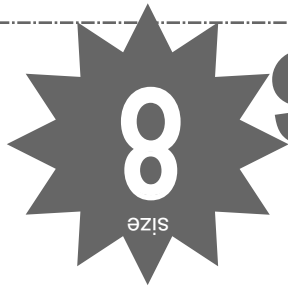

Bonding line BB

# Children's

Bonding line Ca

Bonding line Cb

Bonding line BC

Bonding line BC

Bonding line Da

Bonding line Db

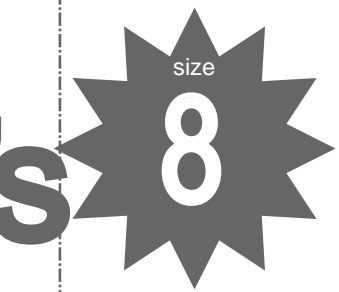

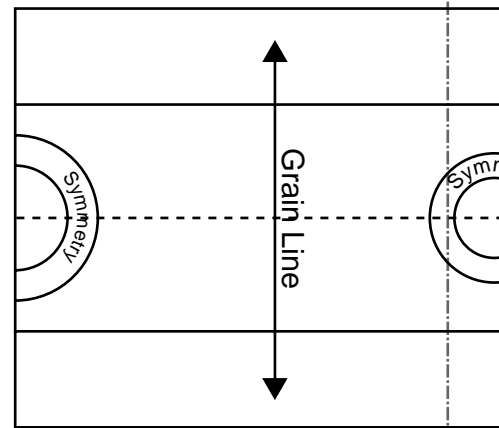

Back

Bonding line BD



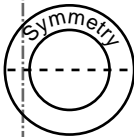

  
**Tshirt7  
Pocket  
one sheets**  
 Seam allowance 1/2in.

**Tshirt7  
Neck  
one sheets**

  
 Seam allowance 1/2in.