

Seam allowance 1/2in.

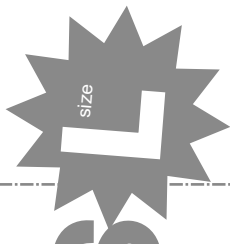

Pumpkin Pants  
Facing  
one sheets  
Fusible interlining  
one sheets



SITE <http://dr-cos.info/en/> <http://dr-cos.com/pl>  
MAIL [info@dr-cos.com](mailto:info@dr-cos.com)  
Twitter [https://twitter.com/dr-cos\\_com](https://twitter.com/dr-cos_com)  
facebook <https://www.facebook.com/dr-cos.com>



Bonding line AA

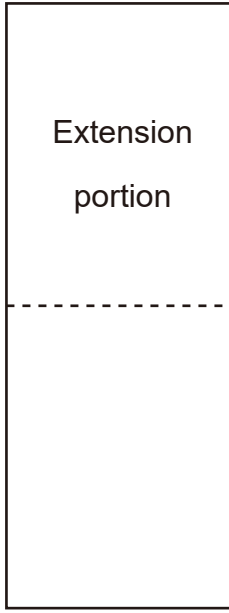

Bonding line Aa

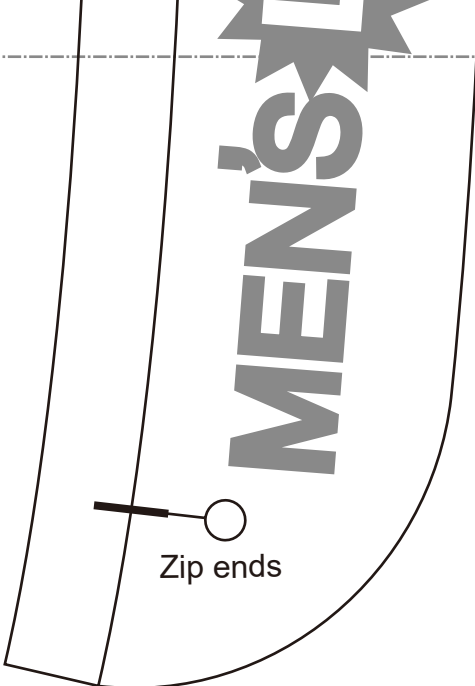

Bonding line AA

**DRCOS**

SITE [http://dr-cos.info\(en\)](http://dr-cos.info(en)) [http://dr-cos.com\(jp\)](http://dr-cos.com(jp))  
MAIL [info@dr-cos.com](mailto:info@dr-cos.com)  
Twitter [https://twitter.com/drcos\\_com](https://twitter.com/drcos_com)  
facebook <https://www.facebook.com/drcoscom>



Bonding line AB

Bonding line Ba

MEN'S **L** size

Bonding line Aa

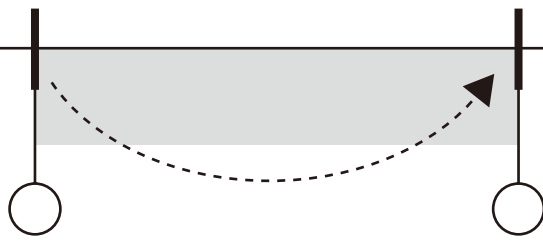

line Ab

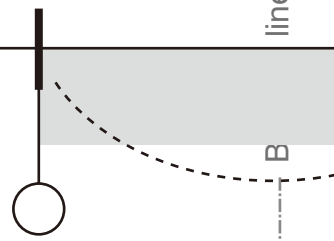

B

Bonding line BA

Bonding line BA

Bonding line Ba

Bonding line Bb



Grain Line

Bonding line BB

Seam allowance 1/2in.

Pump  
one  
Fusible  
one

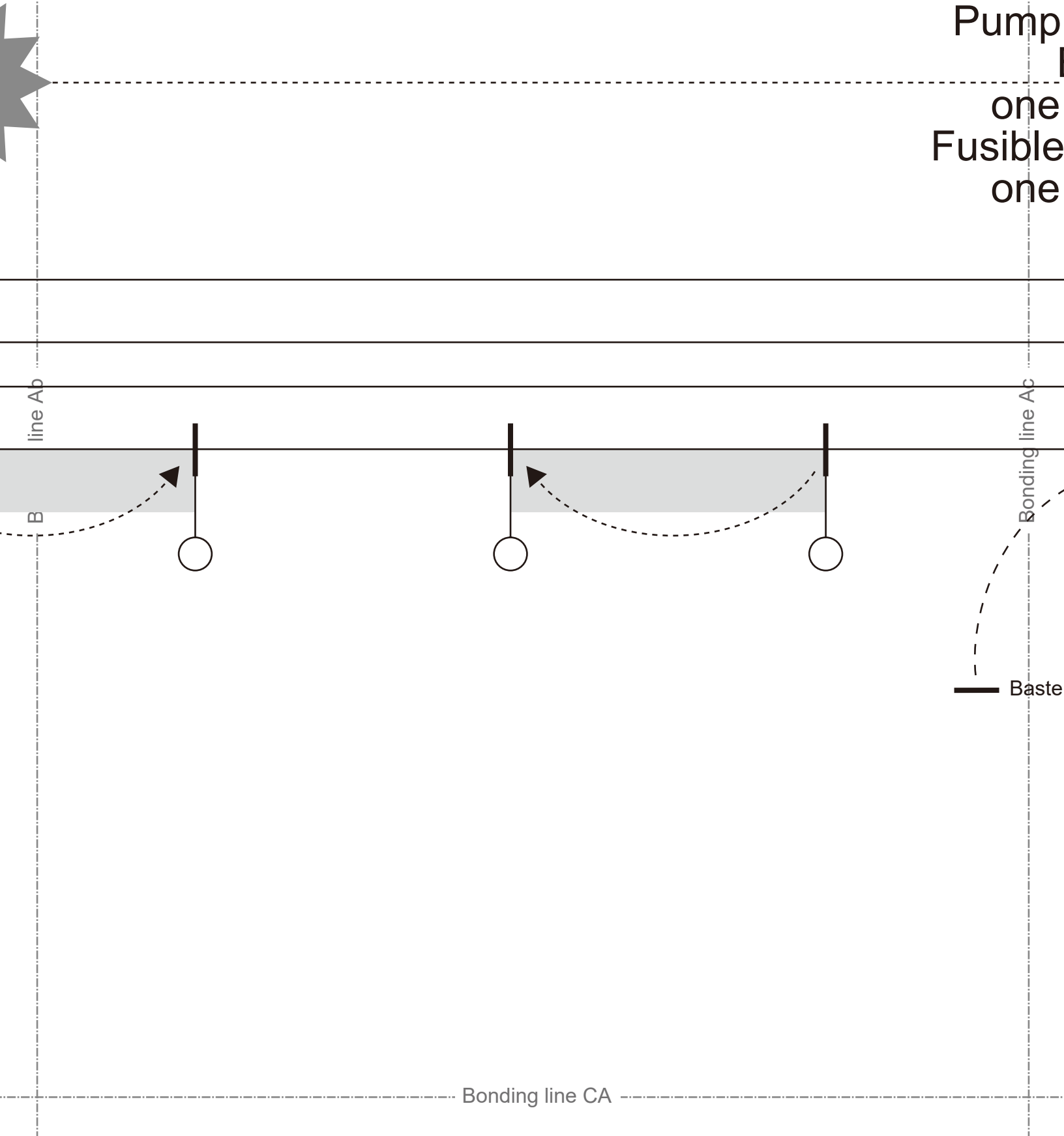

Bonding line CA

# MEN'S

Pumpkin Pa  
Body  
two sheets

Bonding line Bb

Bonding line Bc

Gather

Bonding line CB

# Pumpkin Pants Belt

one sheets  
possible interlining  
one sheets

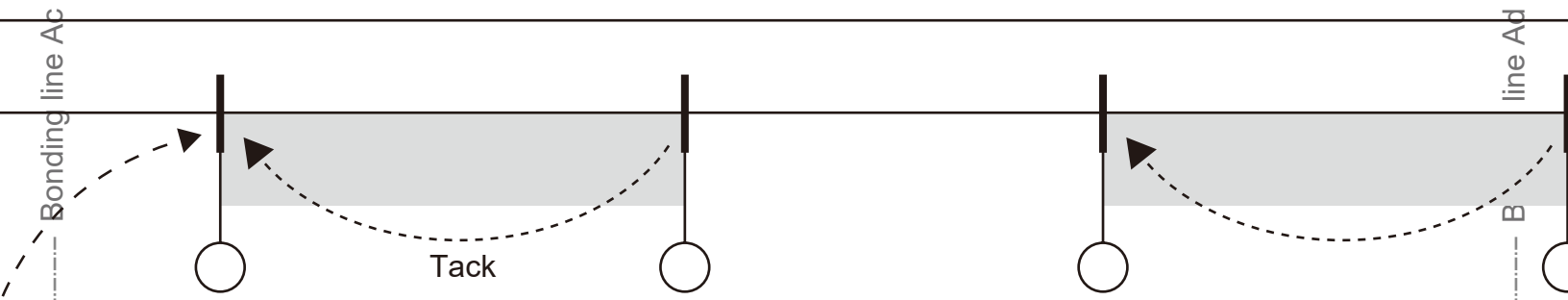

■ Baste

Bonding line DA

Bonding line DA

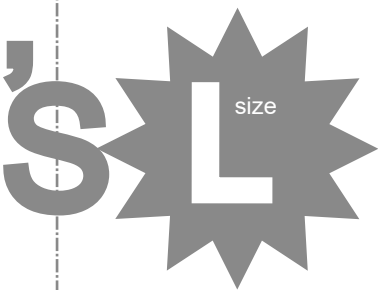

n Pants  
dy  
neets

Bonding line Bc

Bonding line Bd

Bonding line DB



line Ad

B



# DRCOS

SITE [http://dr-cos.info\(en\)](http://dr-cos.info(en)) [http://dr-cos.com\(jp\)](http://dr-cos.com(jp))  
MAIL [info@dr-cos.com](mailto:info@dr-cos.com)  
Twitter [@drcos\\_com](https://twitter.com/@drcos_com)  
facebook <https://www.facebook.com/drcoscom>

Seam allowance 1/2in.

Bonding line EA

Seam allo

SITE [http://dr-cos.info\(en\)](http://dr-cos.info(en)) [http://dr-cos.com\(jp\)](http://dr-cos.com(jp))  
MAIL [info@dr-cos.com](mailto:info@dr-cos.com)  
Twitter [@drcos\\_com](https://twitter.com/@drcos_com)  
facebook <https://www.facebook.com/drcoscom>

# DRCOS

Pumpkin Pants  
Extension parts

size

# VENIS

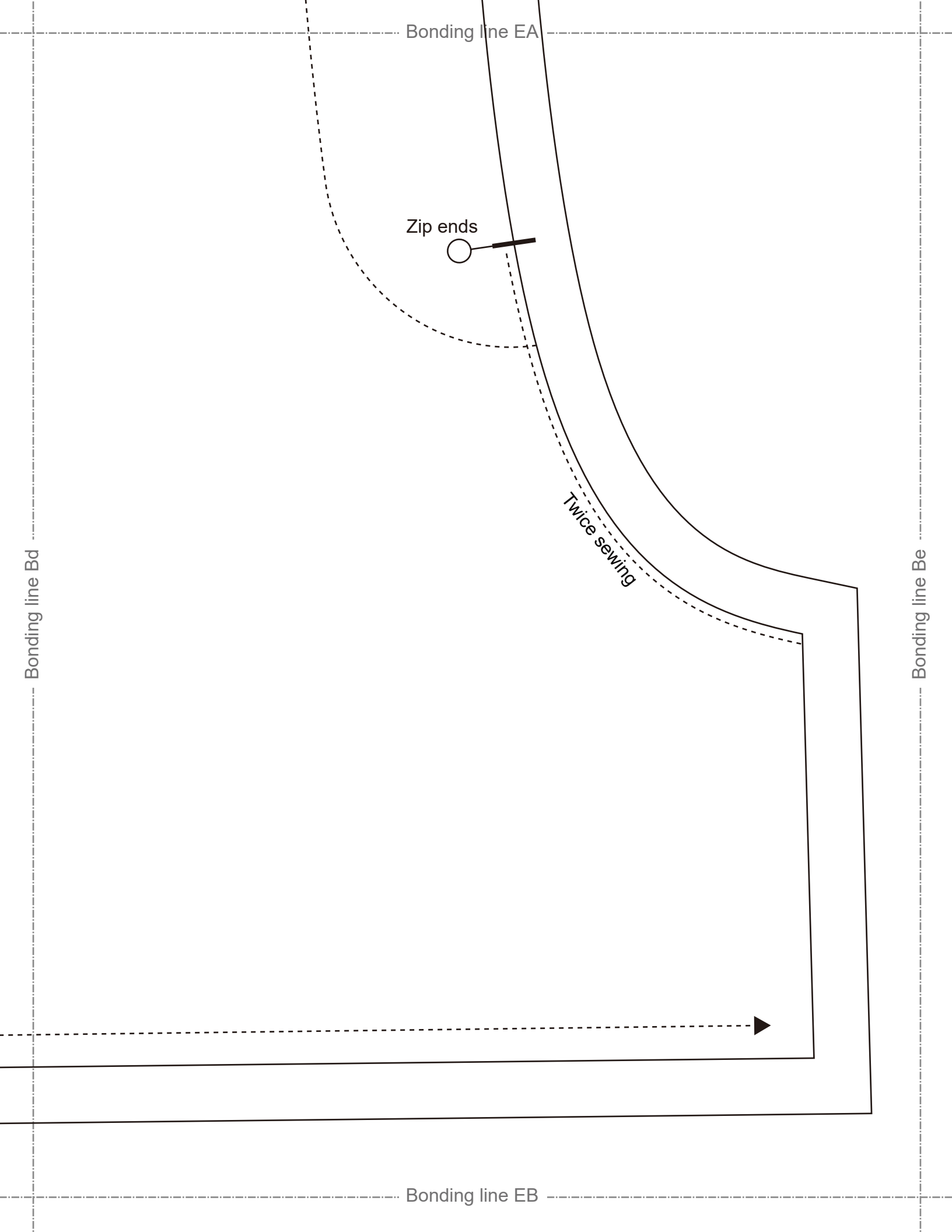

eam allowance 1/2in.

**DRCCOS**

**Pumpkin Pants**  
Extension parts  
one sheets  
Fusible interlining  
one sheets

**MEN'S** size

Zip ends

Grain Line



Grain Line

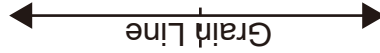

Bonding line FA

Bonding line Af

Bonding line FA

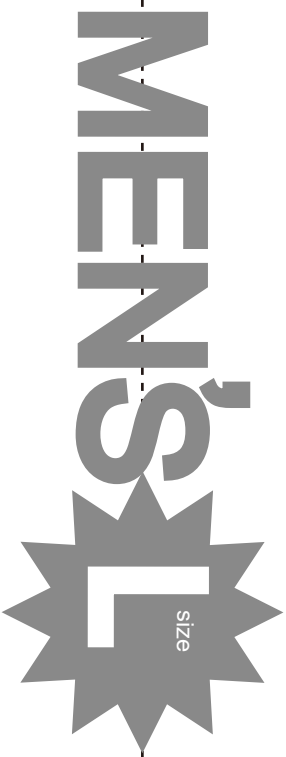

Seam allowance 1/2in.

Pumpkin Pants  
Hem cuffs  
two sheets

Bonding line TB

Bonding line Be

Bonding line Bf

Bonding line Ce

Bonding line FB

ists  
s  
ants



Bonding line Cf

Bonding line FC