

DRCOS

SITE [https://dr-cos.info\(en\)](https://dr-cos.info(en)) [https://dr-cos.com\(jp\)](https://dr-cos.com(jp))
MAIL info@dr-cos.com
Twitter [@drcos_com](https://twitter.com/@drcos_com)
pinterest <https://www.pinterest.jp/drcosinfo>

side

Ex

size

8

Children's

Bonding line AA

Bonding line Aa

Maido

cut on fold

Symmetry

Bonding line AA

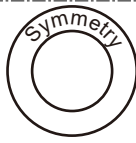

Maido Back Bodice cut one



Bonding line Ba

Seam allowance 1/2in.

Bonding line AB

Bonding line AB

Seam allowance 1/2in.

DRCOS
 SITE <https://dr-cos.info/en> <https://dr-cos.com/jp>
 MAIL info@dr-cos.com
 T witter <https://twitter.com/dr-cos>
 pinterest <https://www.pinterest.jp/dr-cos/info>

Grain Line

Maido
 Front Bodice
 cut two

Children's



Bonding line Ca

Bonding line AC

Bonding line AC



Facing line

Baste

Button
&
Buttonhole
Position



Collar position

Bonding line Da

Bonding line AD

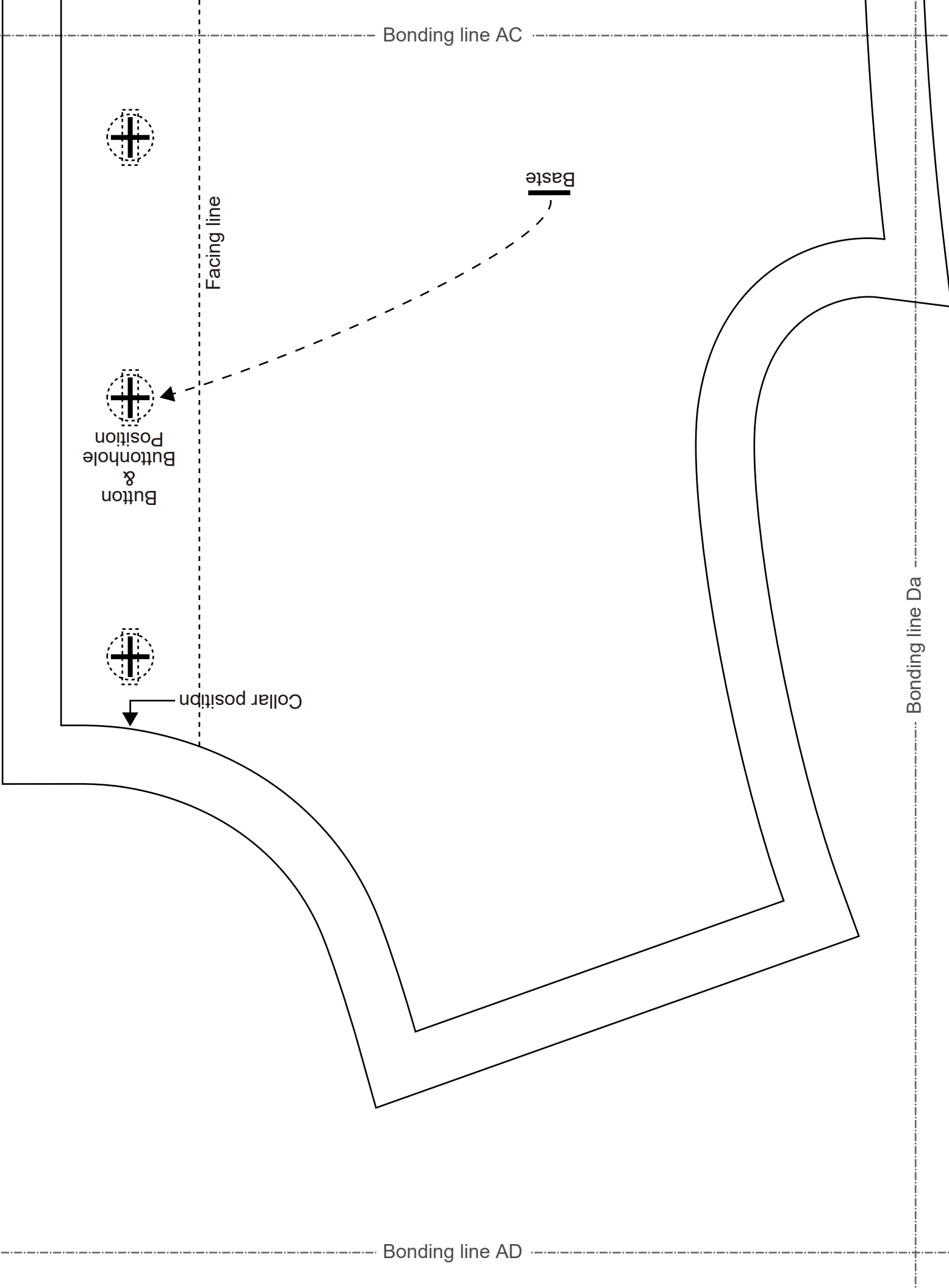

Baste position



Extension part

Grain Line



Bonding line Aa

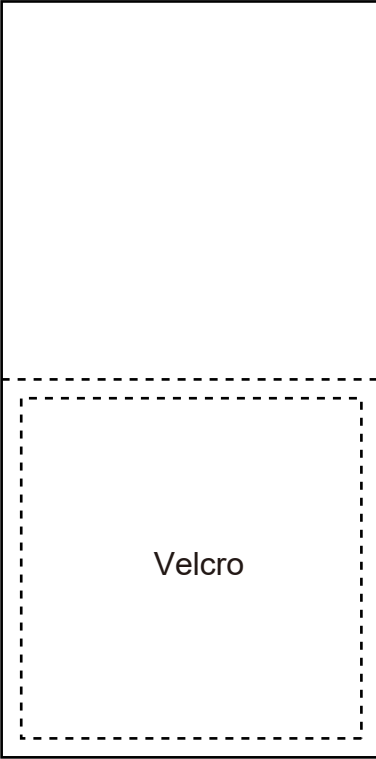

Velcro

Grain Line

Bonding line Ab



SITE <https://dr-coos.info/en/>
MAIL info@dr-coos.cdm
TWITTER <https://twitter.com/drcc>
PINTEREST <https://www.pinterest.com/drcc/>

Bonding line BA

www.sccos.com
info@sccos.com
1-800-333-3333

SCCOS

Bonding line BA

Bonding line Ba

Bonding line Bb

Bonding line BB

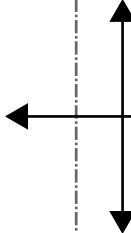

Bonding line BB

Seam allowance 1/2in.

Bonding line Ca

Bonding line Cb

Grain Line

Maido
Apron
lining
cut one



Bonding line BC

d ruffle

Bonding line Da

Bonding line BC

Gathered ruffle

Bonding line Db

Bonding line BD

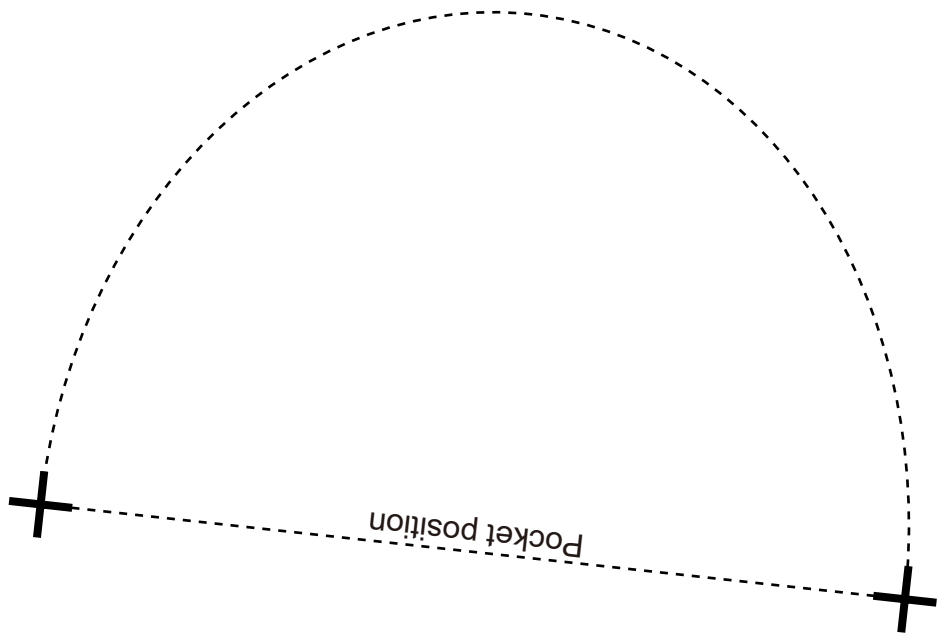

DRCOS
SITE <https://dr-cos.info/en> <https://dr-cos.com/jp>
MAIL info@dr-cos.com
TWITTER https://twitter.com/drcos_com
PINTEREST <https://www.pinterest.jp/drcosinfo>

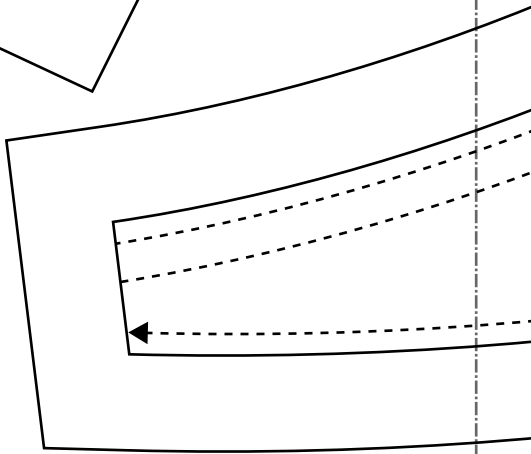

Children's  size 8

Maido
Waist band
Interfacing
cut one

Seam allowance 1/2in.

Bonding line Ab

Children's  size 8

Maido
Apron waist
Interfacing
cut one

Bonding line AC

Center Match mark



Seam allowance 1/2in.



Bonding line CA

Bonding line CA

Bonding line Bb

Bonding line Bc

Children's **8**^{size}



**Maido
Bodice
cut two**

Bonding line CB

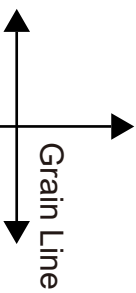

Bonding line CB



Bonding line Cb

Bonding line Cc

Bonding line CC

d ruffle

n.

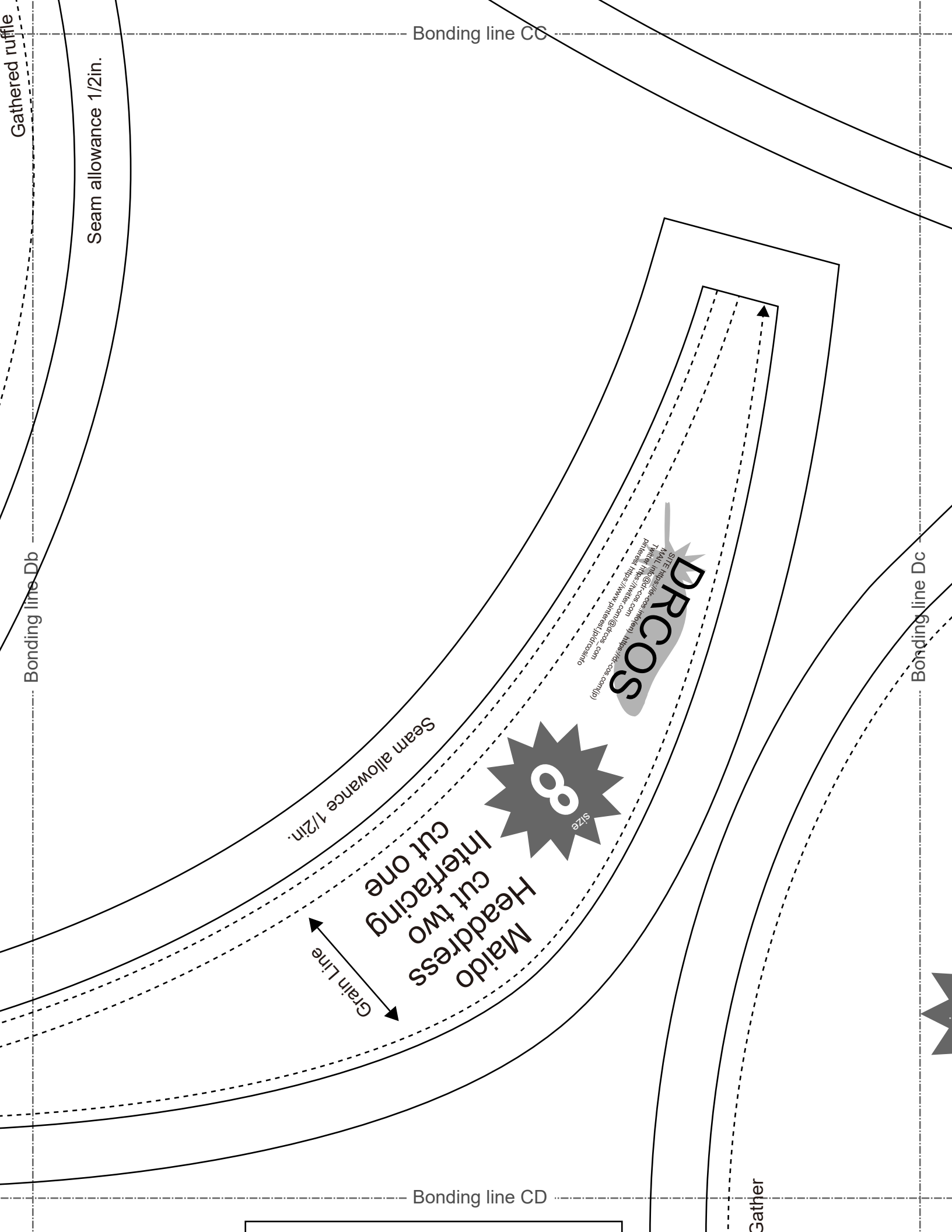

Bonding line CC

Seam allowance 1/2in.

Bonding line Db

Seam allowance 1/2in.

Grain Line

Maído Headdress cut two
Interfacing cut one

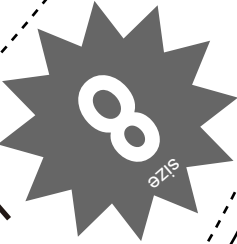

DRCOS
SITE: <https://drcos.com/>
MAIL: info@drcos.com
Twitter: <https://twitter.com/drcos>
Pinterest: <https://www.pinterest.jp/drcosinfo>
(c) drcos.com

Bonding line Dc

Bonding line CD

Gather

Bonding line CD

Gather

Bonding line Ec

Bonding line Eb

Seam allowance 1/2in.

Grain Line

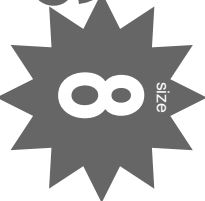
Children's  **8**

**Maido
Cuff**
Interfacing
cut two

 SITE <https://dr-cos.info/en/> <https://dr-cos.com/fp>
 MAIL info@dr-cos.com @dr-cos_com
 Twitter https://twitter.com/@dr-cos_com
 pinterest <https://www.pinterest.jp/dr-cos/info>

DRCOS

SITE [https://dr-cos.info\(en\)](https://dr-cos.info(en)) [https://dr-cos.com\(jp\)](https://dr-cos.com(jp))
MAIL info@dr-cos.com
Twitter https://twitter.com/@drcos_com
pinterest <https://www.pinterest.jp/drcosinfo>

Center line

side

Maido
on waist band
interfacing
cut one

Velcro

Bonding line Ad

DRCOS

SITE [https://dr-cos.info\(en\)](https://dr-cos.info(en)) [https://dr-cos.com\(jp\)](https://dr-cos.com(jp))
MAIL info@dr-cos.com
Twitter https://twitter.com/@drcos_com
pinterest <https://www.pinterest.jp/drcosinfo>

Bonding line DA

Bonding line DA

Bonding line Bc

Bonding line Ba

Apply anti-stretch tape.

End of sewing

Bonding line DB

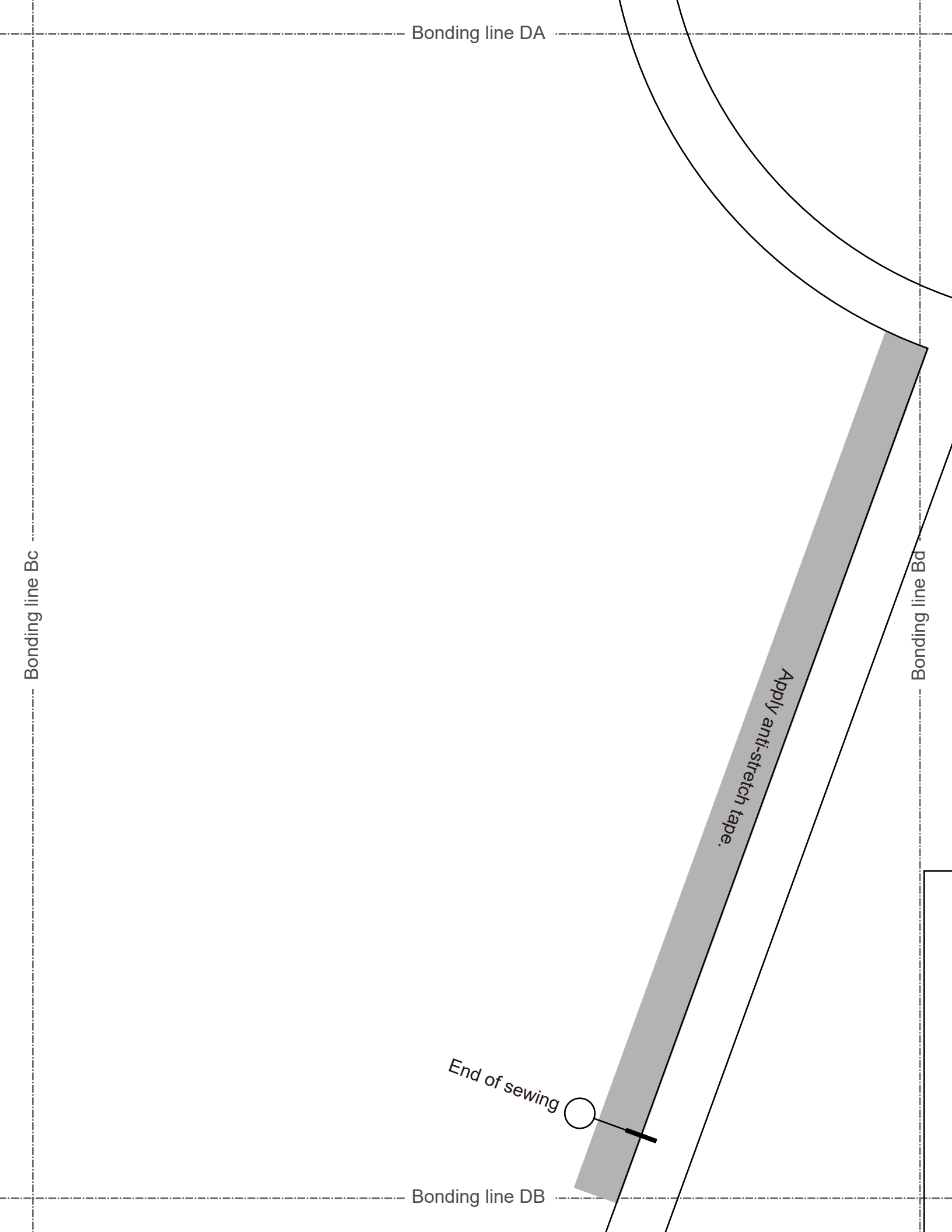

Bonding line Cc

Bonding line DB

Seam allowance 1in.

Maido
Pocket
cut two

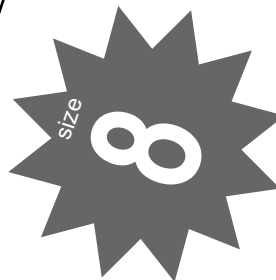

SITE <https://drcosinfo.com/>
MAIL info@drcos.com
Twitter <https://twitter.com/drcos>
Pinterest <https://www.pinterest.com/drcos/>

Seam allowance 1/2in.

Bonding line DC

Grain Line

Bonding line Cd

11/27/2020 09:48:00 AM

size
8
en's

aido
eve
two

Bonding line DD

Gather

allowance 1/2in.

facing
t two

Machined edge

size
8
Children's

Back

DRCOS

SITE <https://dr-cos.info/en> <https://dr-cos.com/jp>
MAIL info@dr-cos.com
Twitter [@drcos_com](https://twitter.com/@drcos_com)
Pinterest <https://www.pinterest.jp/drcosinfo>

Bonding line DC

Grain Line

Seam

Bonding line Dc

Bonding_line_Dd

Children

Bonding line Ec

Grain Line

Maido Sleeve cut two

Bonding line DD

Gather

Seam allowan

Front

Maido Facing cut two

Interfacing cut two

Grain Line

Seam allowance 1/2in.

DRCOS

SITE <https://dr-cos.info/en> <https://dr-cos.com/ip>
MAIL info@dr-cos.com
Twitter [@drcos_com](https://twitter.com/@drcos_com)
Pinterest <https://www.pinterest.jp/drcosinfo>

Bonding line Ed

OS
/dr-cos.com(jp)
.com
drcosinfo

Bonding line Ad



Bonding line FA

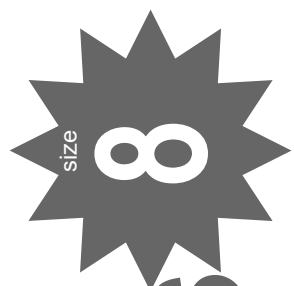

children's

Maido
Ribbon(top part)
Interfacing
cut one

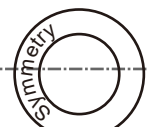

Bonding line Ae

Bonding line EA

Chili

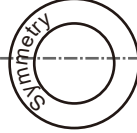

Bonding line Ba

Bonding line Be



Bonding line EB

Bonding line EB

Bonding line EC

Bonding line Cd

Bonding line Ce

Seam allowance 1/2in.

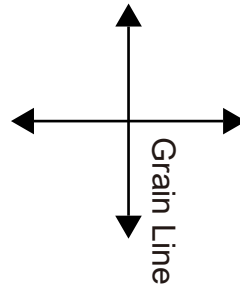

Bonding line EC

Bonding line Dd

Bonding line De

Children's

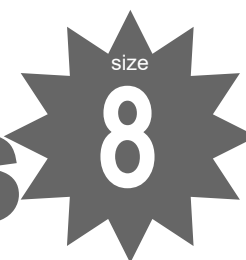

Velcro

Velcro

Maido
Ribbon core
Interfacing
cut one

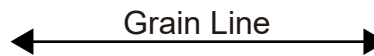

DRCOS

SITE <https://dr-cos.info/en> <https://dr-cos.com/jp>
MAIL info@dr-cos.com
Twitter [@drcos_com](https://twitter.com/@drcos_com)
pinterest <https://www.pinterest.jp/drcosinfo>

Seam allowance 1/2in.

Bonding line ED

Bonding line Ae

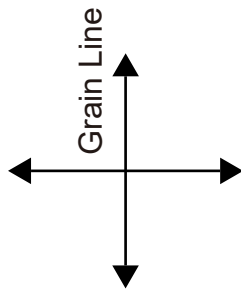

Bonding line FA

Seam allowance 1/2in.

Bonding line FA

Bonding line Be

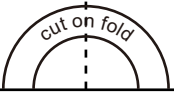

Bonding line FB

Children's size 8



Maido
Ribbon(lower part)
cut one

Bonding line FC

Bonding line De

DRCOS
 SITE <https://dr-cos.info/en> <https://dr-cos.com/jp>
 MAIL info@dr-cos.com
 Twitter https://twitter.com/dr-cos_com
 pinterest <https://www.pinterest.jp/drcosinfo>

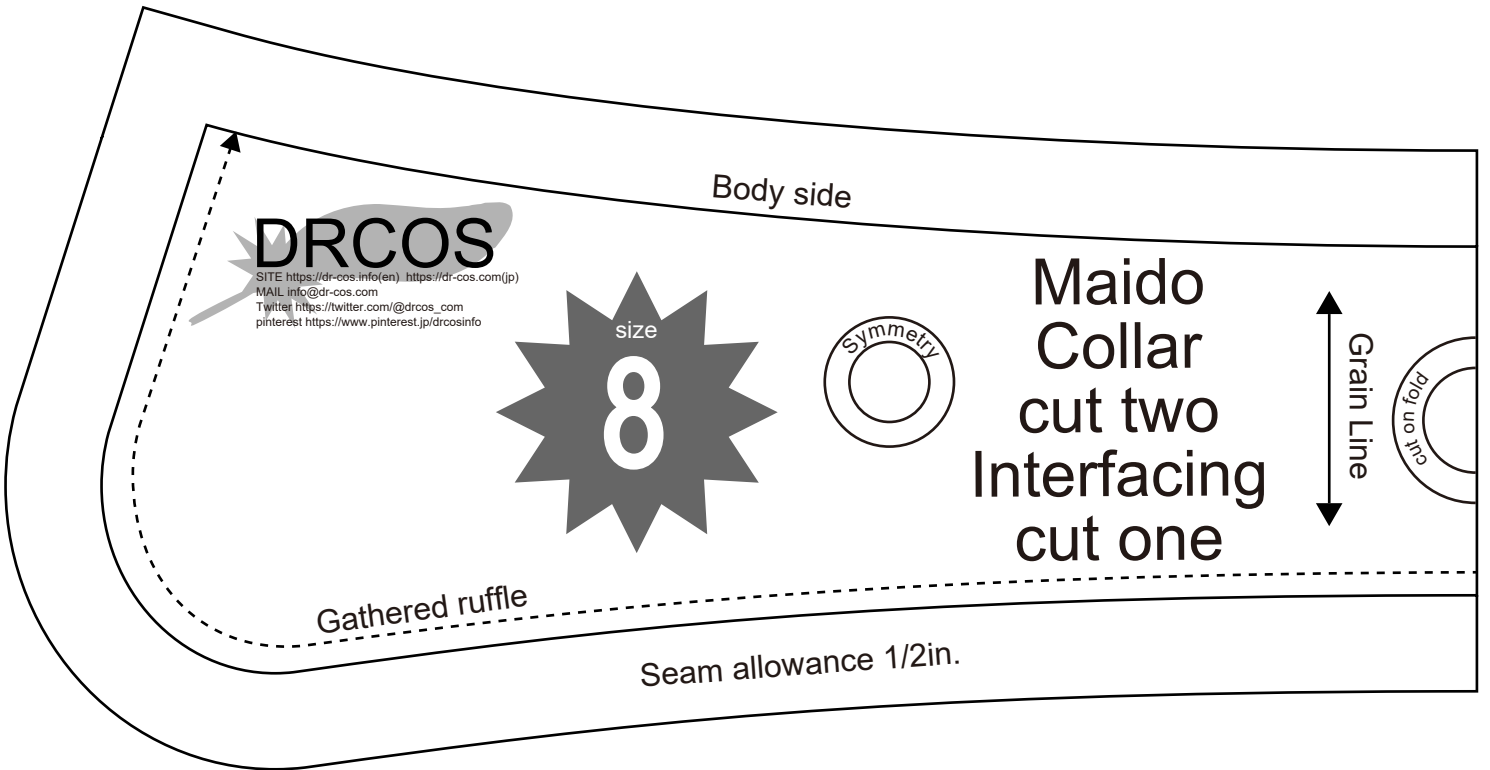

Bonding line FD