

Bonding line Aa

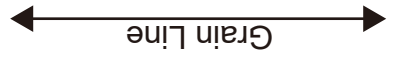

Bonding line AA

**DRCOS**  
SITE <http://dr-cos.info/en> <http://dr-cos.com/fp>  
MAIL [info@dr-cos.com](mailto:info@dr-cos.com)  
TWITTER [https://twitter.com/dr-cos\\_com](https://twitter.com/dr-cos_com)  
FACEBOOK <https://www.facebook.com/dr-cos.com>

Seam allowance 1/2in.

Bonding line AA

Bonding line Ba

Bonding line AB

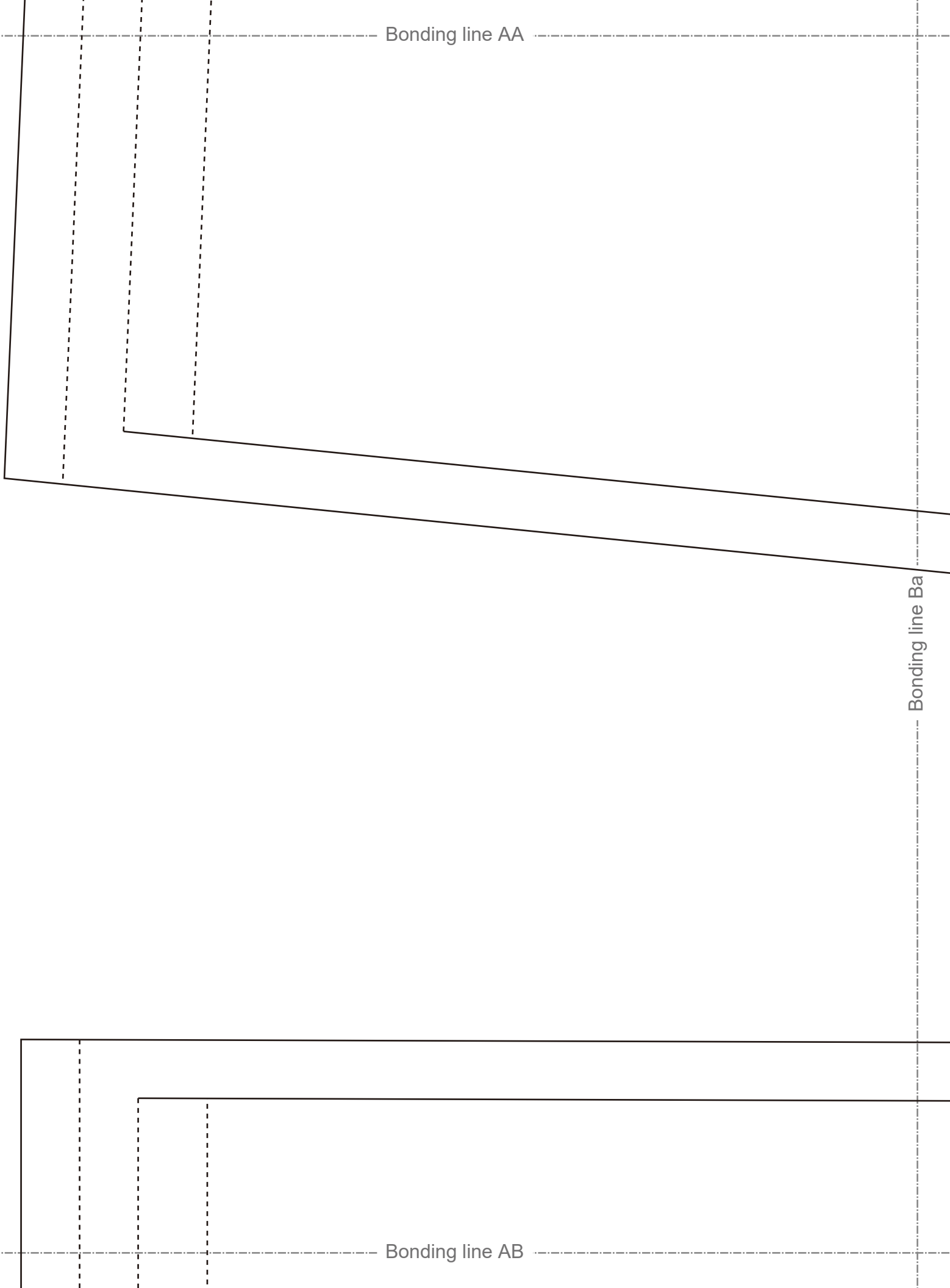

Bonding line AB

Bonding line Ca

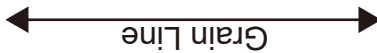

Grain Line

Seam allowance 1/2in.

**DRCOS**  
 SITE <http://dr-cos.info/en/> <http://dr-cos.com/p/>  
 MAIL [info@dr-cos.com](mailto:info@dr-cos.com)  
 Twitter <https://twitter.com/dr-cos>  
 facebook <https://www.facebook.com/drcoscom>

Bonding line AC

Bonding line Aa

Bonding line Ab

**Knickerbockers**  
**Back Body**  
**two sheets**



Bonding line BA



Bonding line BA

Bonding line Ba

Bonding line Bb

Bonding line BB

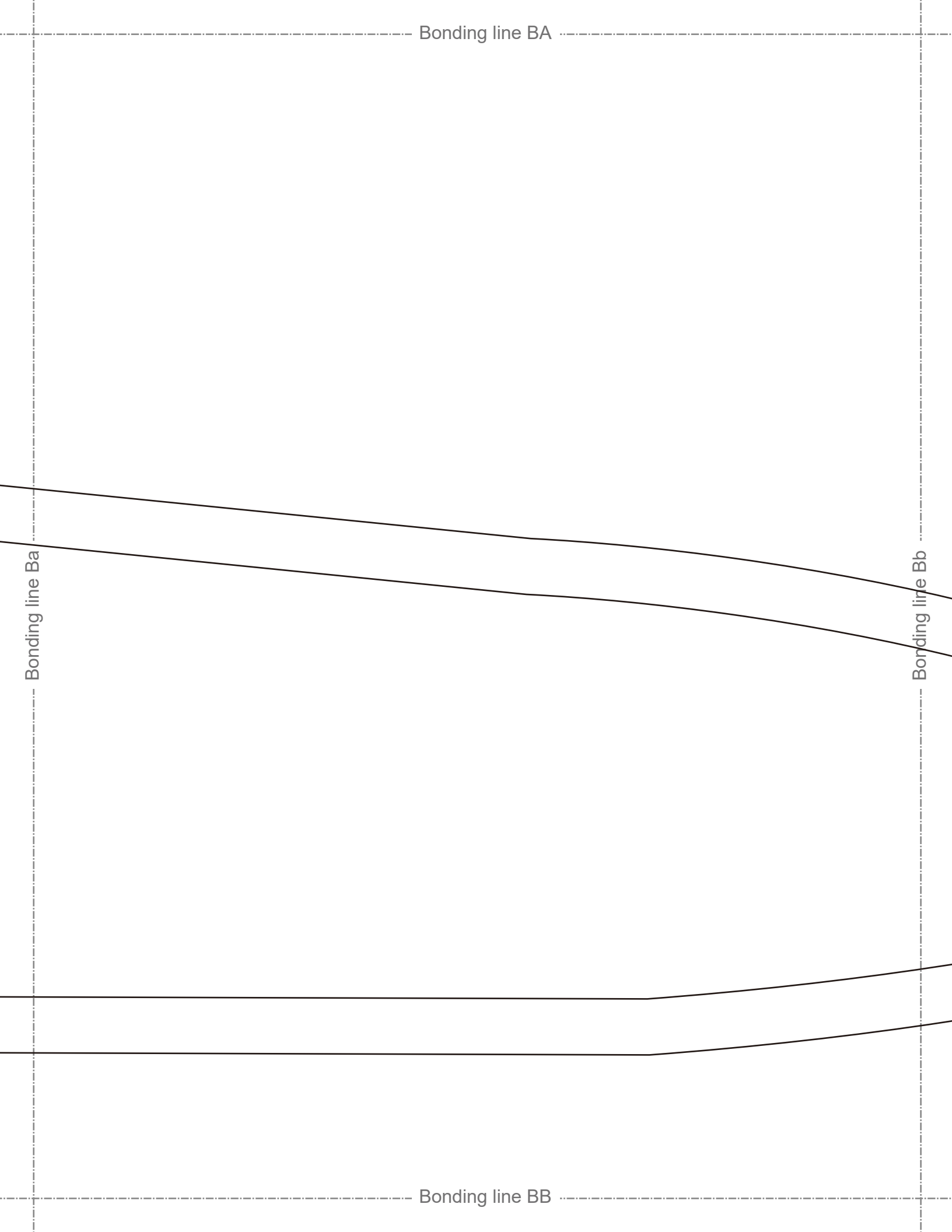

Bonding line BB

**LADIES'S**  
Knickerbockers  
Front Body  
two sheets

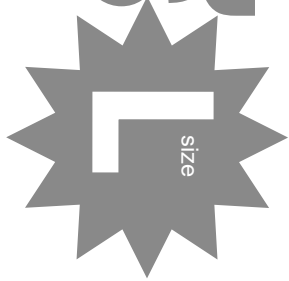

Bonding line Ca

Bonding line Cb

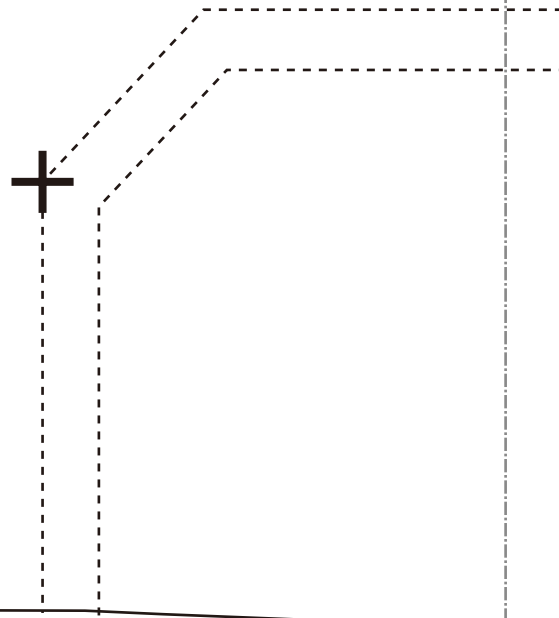

Bonding line BC

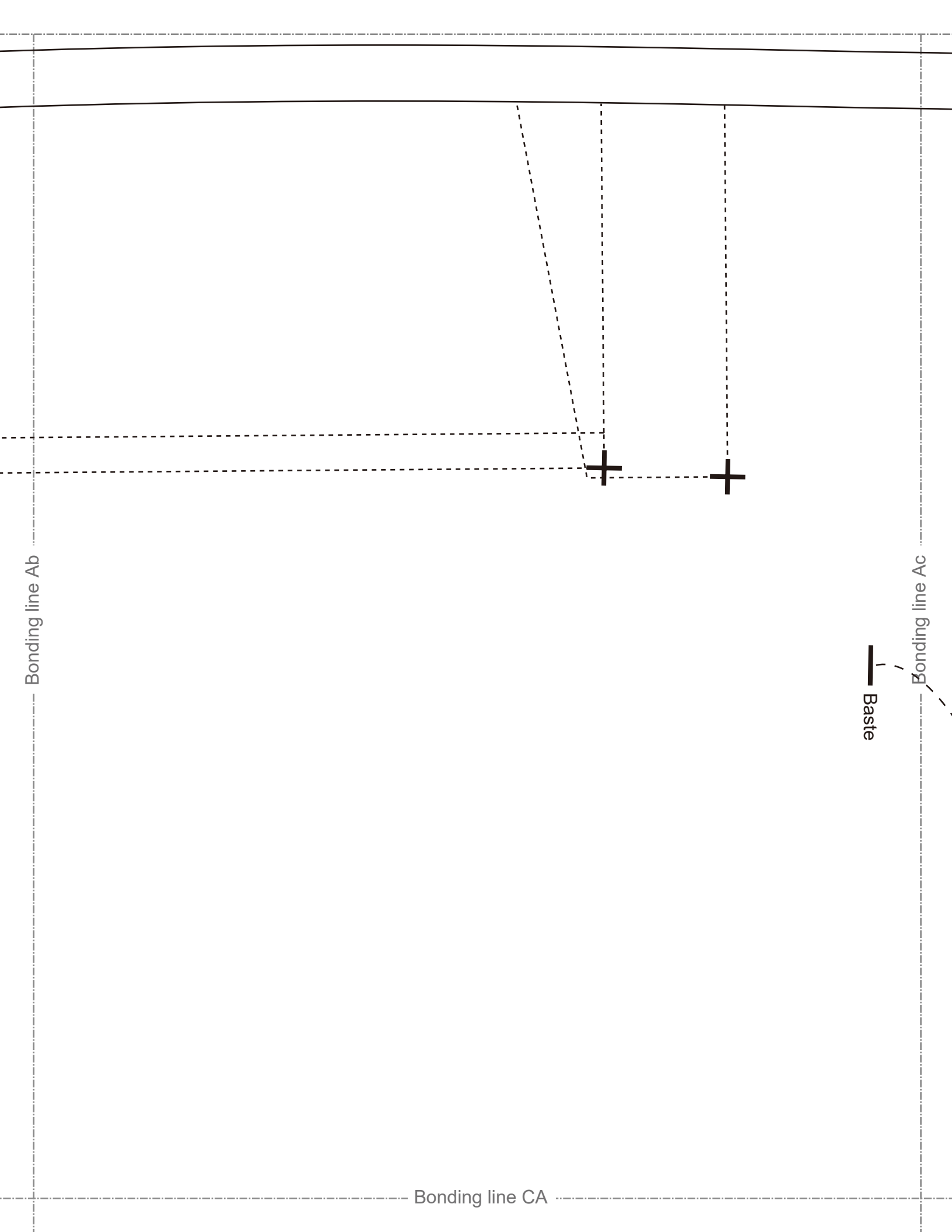

Bonding line Ab

Bonding line CA

Bonding line Ac

 Baste

Bonding line CA

Bonding line Bb

Bonding line Bc

Bonding line CB

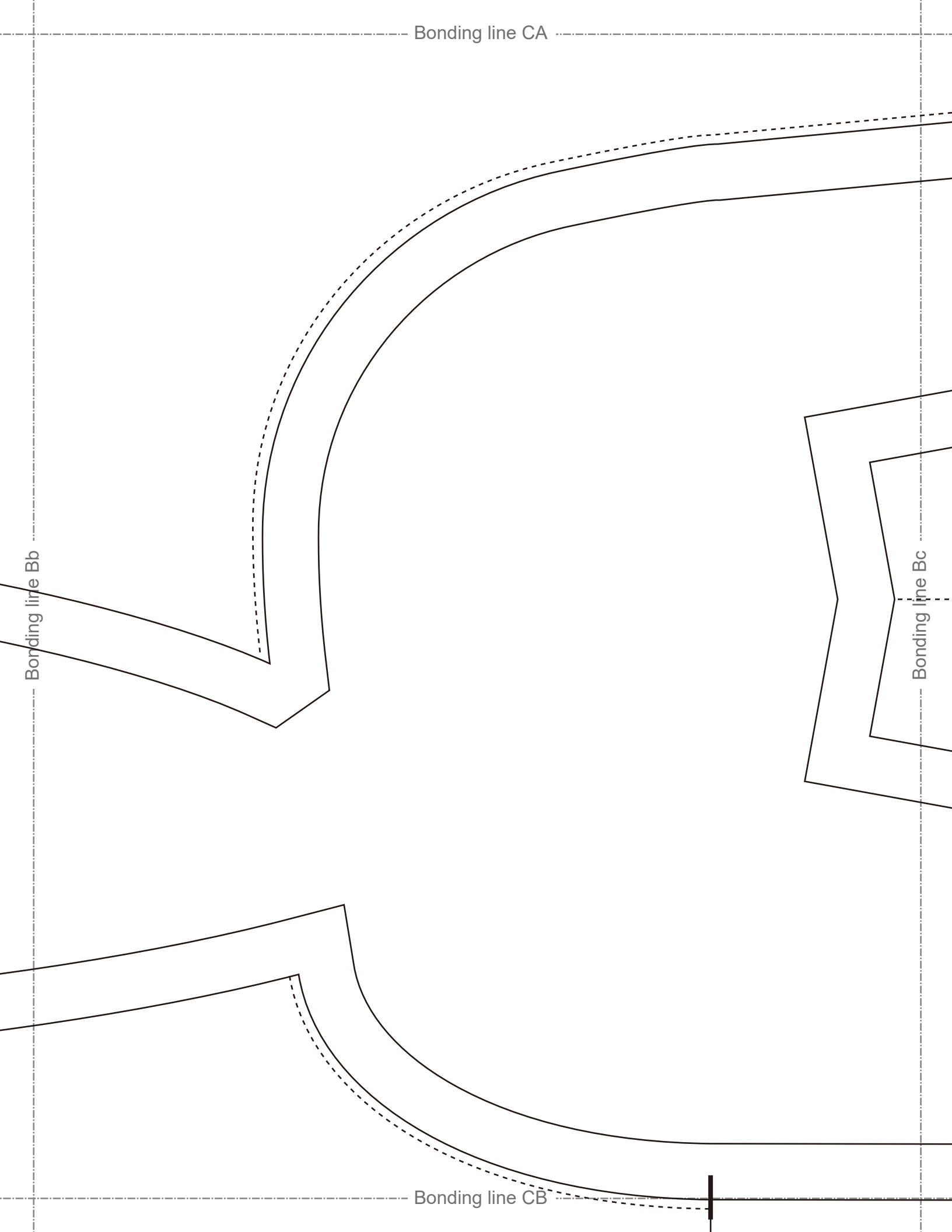



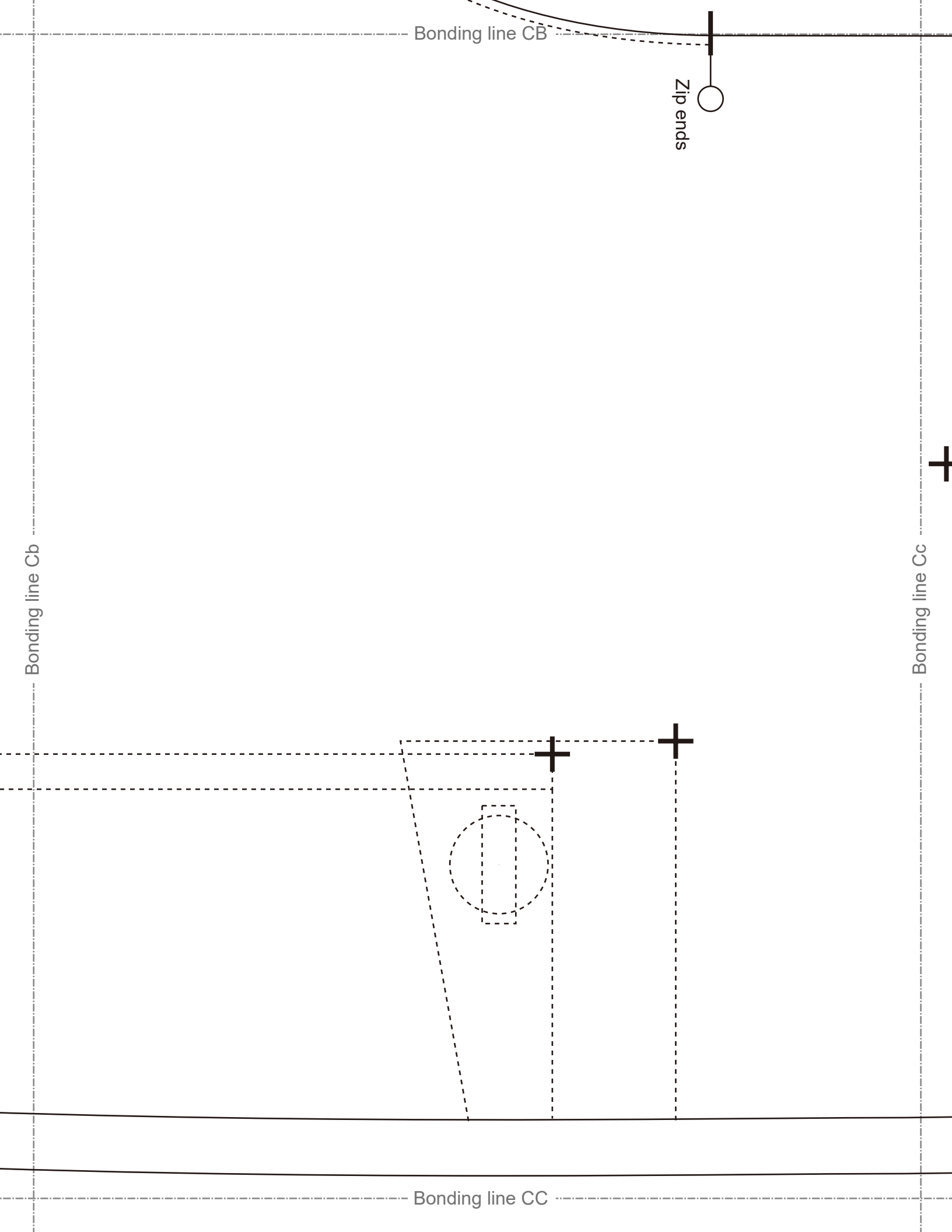

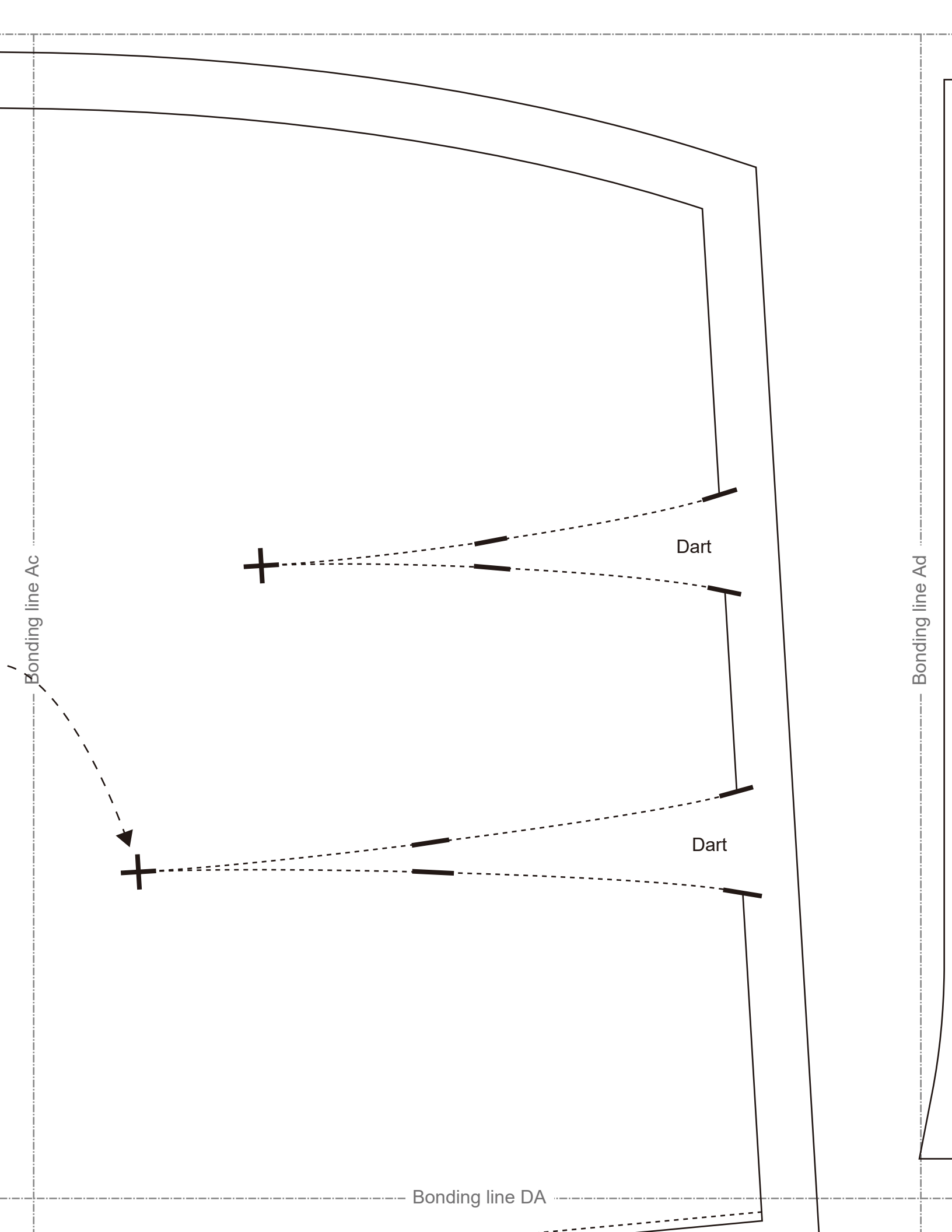

Bonding line DA

Bonding line Bc

Bonding line Bd

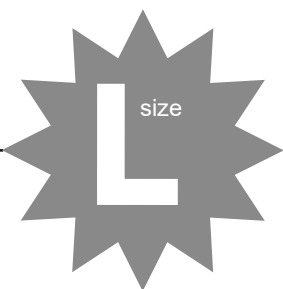

Buttonhole position

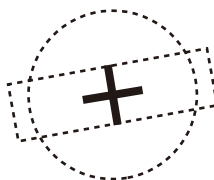

# Knickerbockers flap two sheets

Seam allowance 1/2in.

Bonding line DB

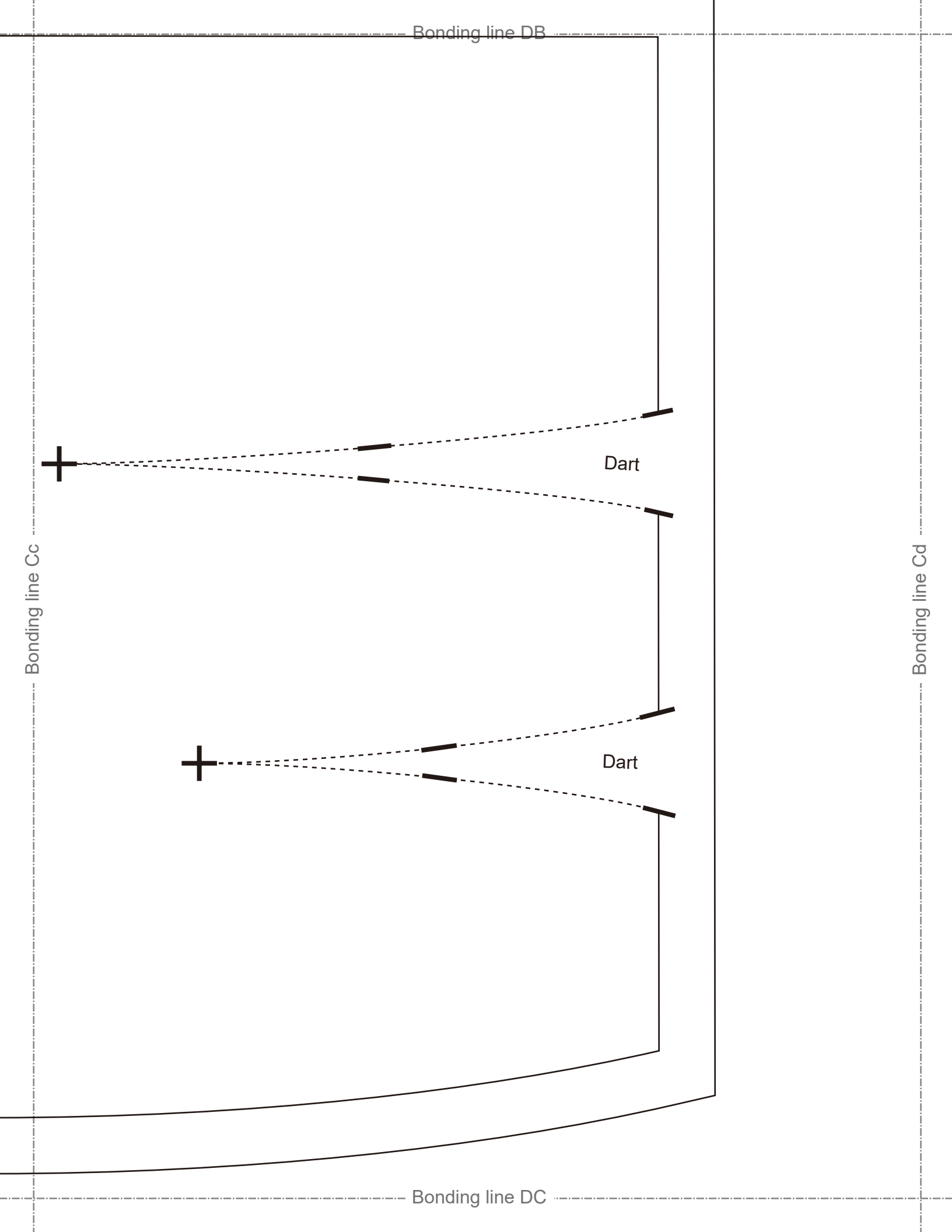

Bonding line DB

Bonding line DC

Bonding line Cc

Bonding line Cd

Dart

Dart



Bonding line DC

Bonding line Dc

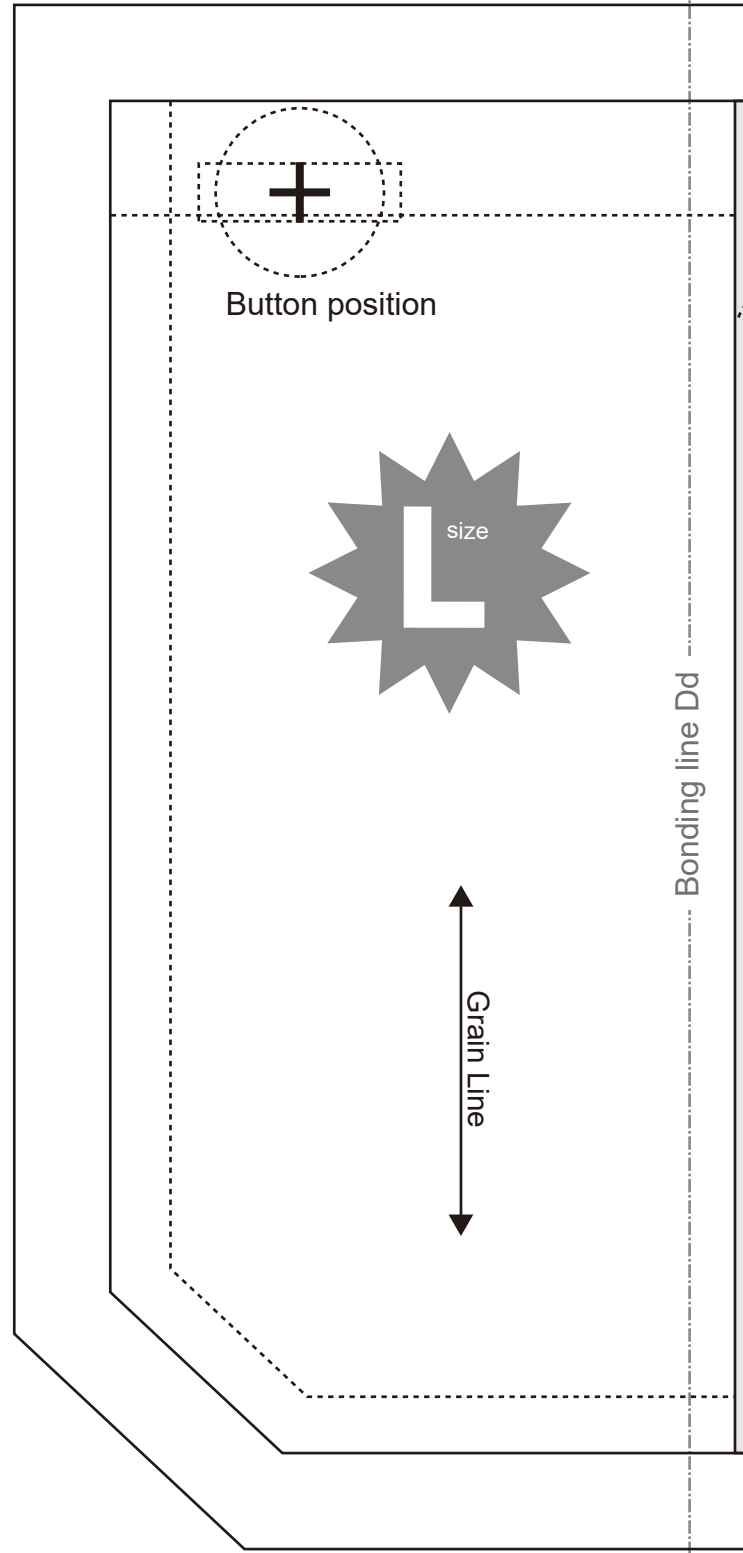

Button position

size

Grain Line

Bonding line Dd

Bonding line DD

Seam allowance 1/2in.



**Knickerbockers**  
**Extension parts**  
 one sheets  
**Fusible interlining**  
 one sheets

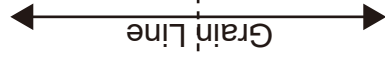
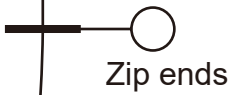
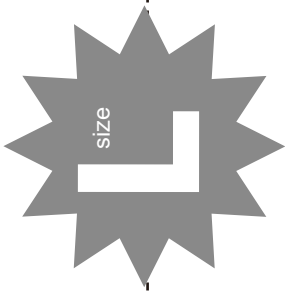

Bonding line Be

Seam allowance 1/2in.

**Knickerbockers  
Belt**

one sheets  
Fusible interlining  
one sheets

**LAD**

Bonding line EA

Bonding line EB

Bonding line Bd

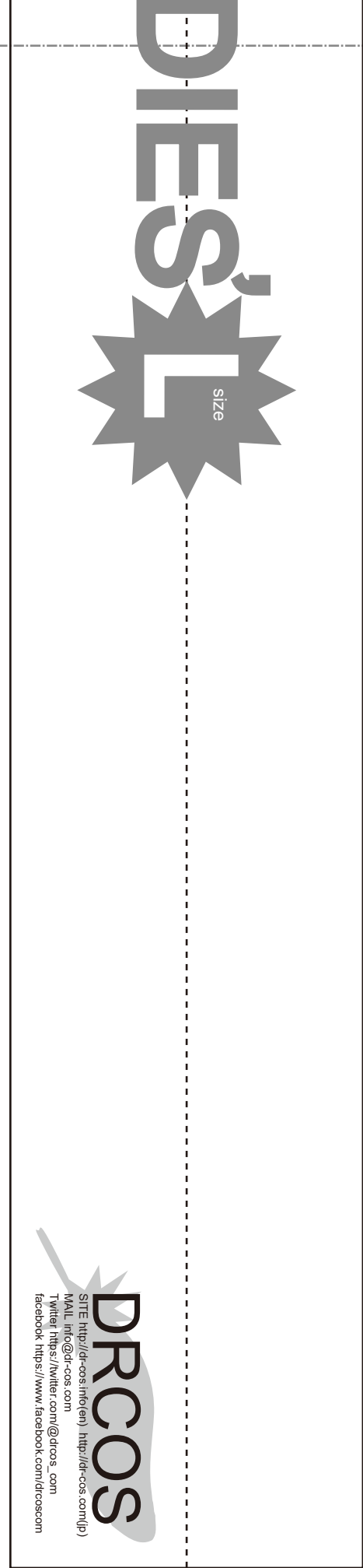
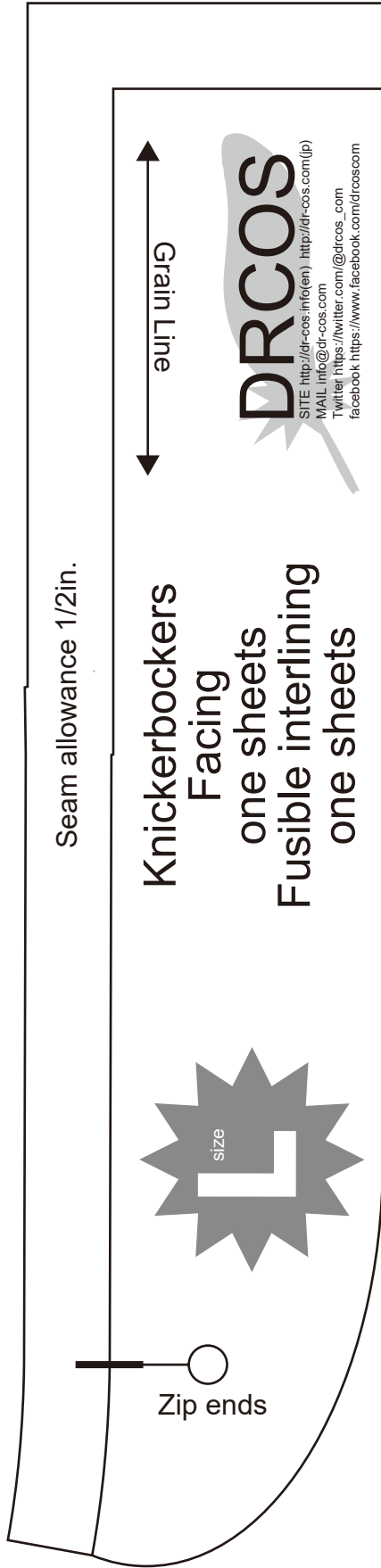



Bonding line EC

Bonding line Dd

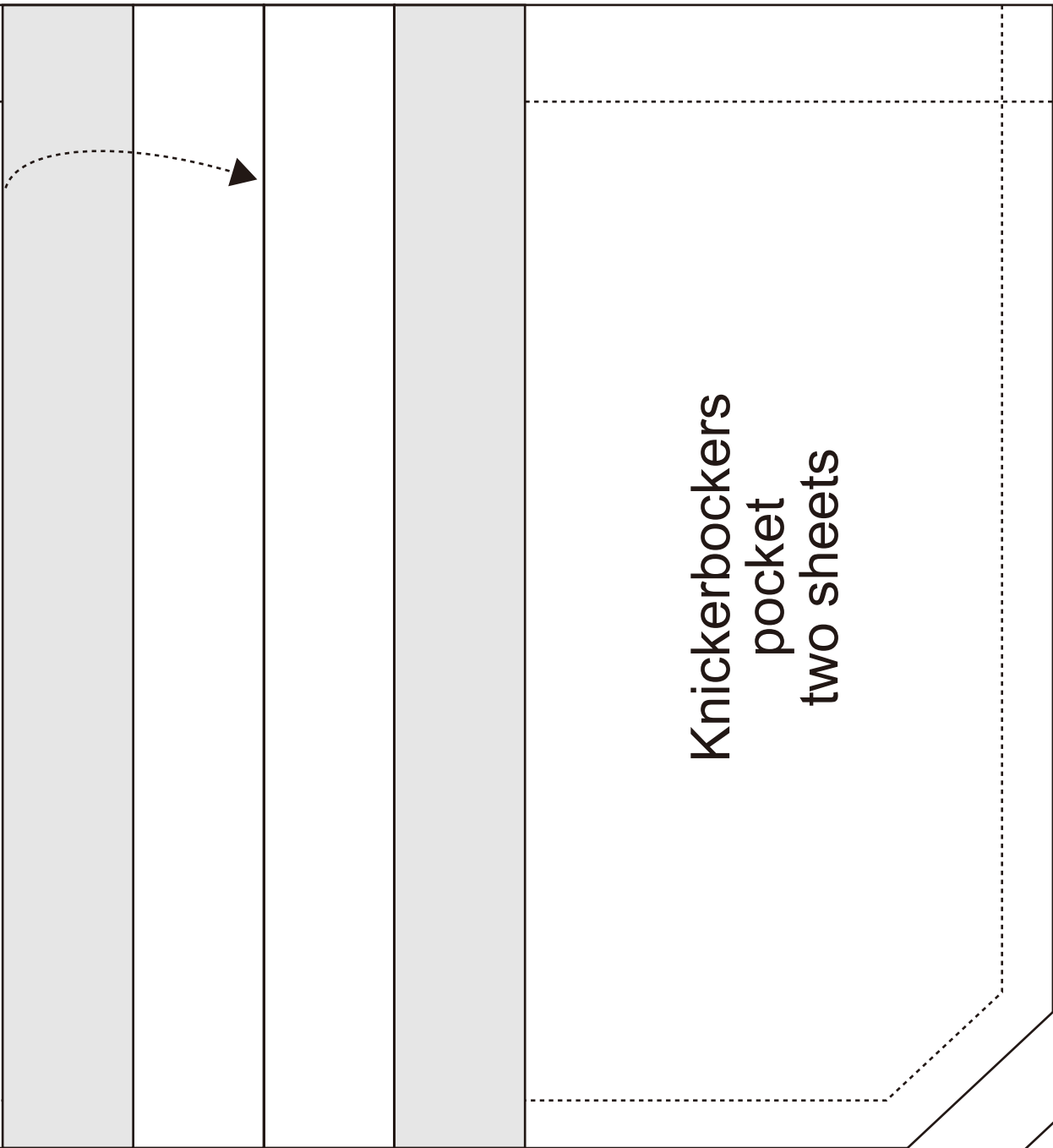

Seam allowance 1/2in.

Knickerbockers  
pocket  
two sheets

Bonding line De

Bonding line ED