

Seam allowance 1/2in.

Bonding line AA



Bonding line Aa

Bonding line AA



A-Line Coat
Front body facing
two sheets
Fusible interlinings
two sheets

Bonding line AB



on Hole Position

Bonding line Ba

Facing Line

Coat
facing
ets
erlining
ets

Bonding line AB



Bonding line Ca

Unisex

Collar position



Bonding line AC

MEN'S
size



Bonding line AC

Bonding line Da

Bonding line AD

Belt threading
two sheets

Seam allowance 1/2in.



facebook <https://www.facebook.com/drcos.com>
Twitter [@drcos_com](https://twitter.com/drcos_com)
MAIL info@drcos.com
SITE <http://drcos.info/en> <http://drcos.com/jp>

DRCOS

Bonding line Aa

Bonding line Ab

Bonding line BA

Pocket position

V-Line Coat
Front body
two sheets



Bonding line BB

Baste



Facing Line

Bonding line Ba

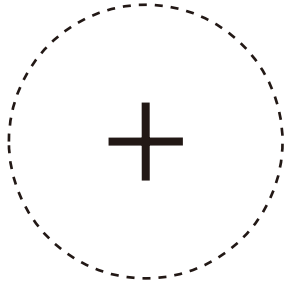

Button & Button Hole

Bonding line BA



Set position

Bonding line Bb

Bonding line BB

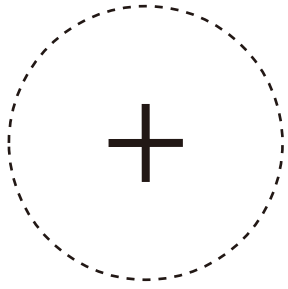
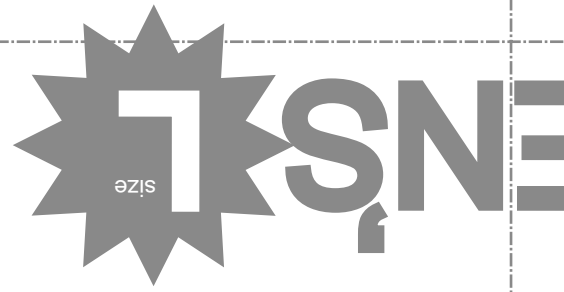

Bonding line Ca

Center position

Bonding line Cb

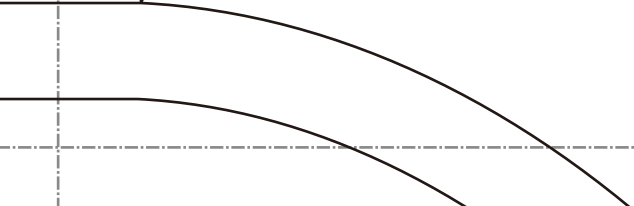
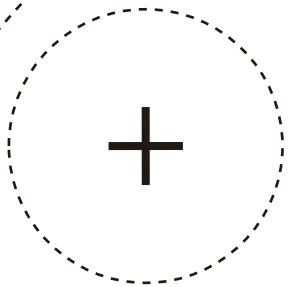

Bonding line BC

Bonding line BC

Bonding line Da

Bonding line Db

DRCCOS
 (419) 433-3333
 www.drccos.com
 Email: info@drccos.com
 Website: http://www.drccos.com
 Text: 1-800-433-3333

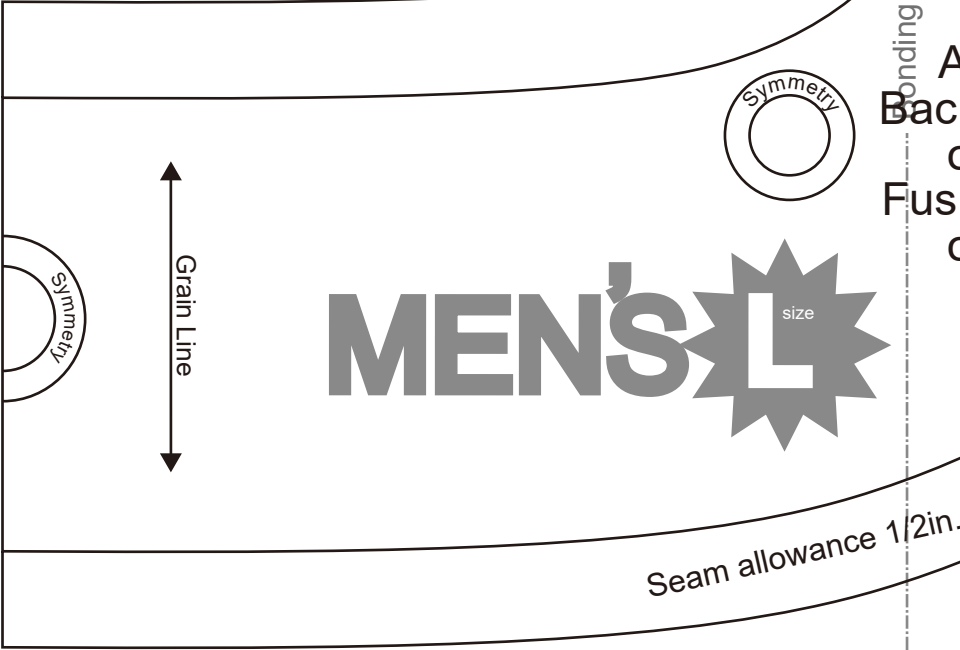

Bonding line BD

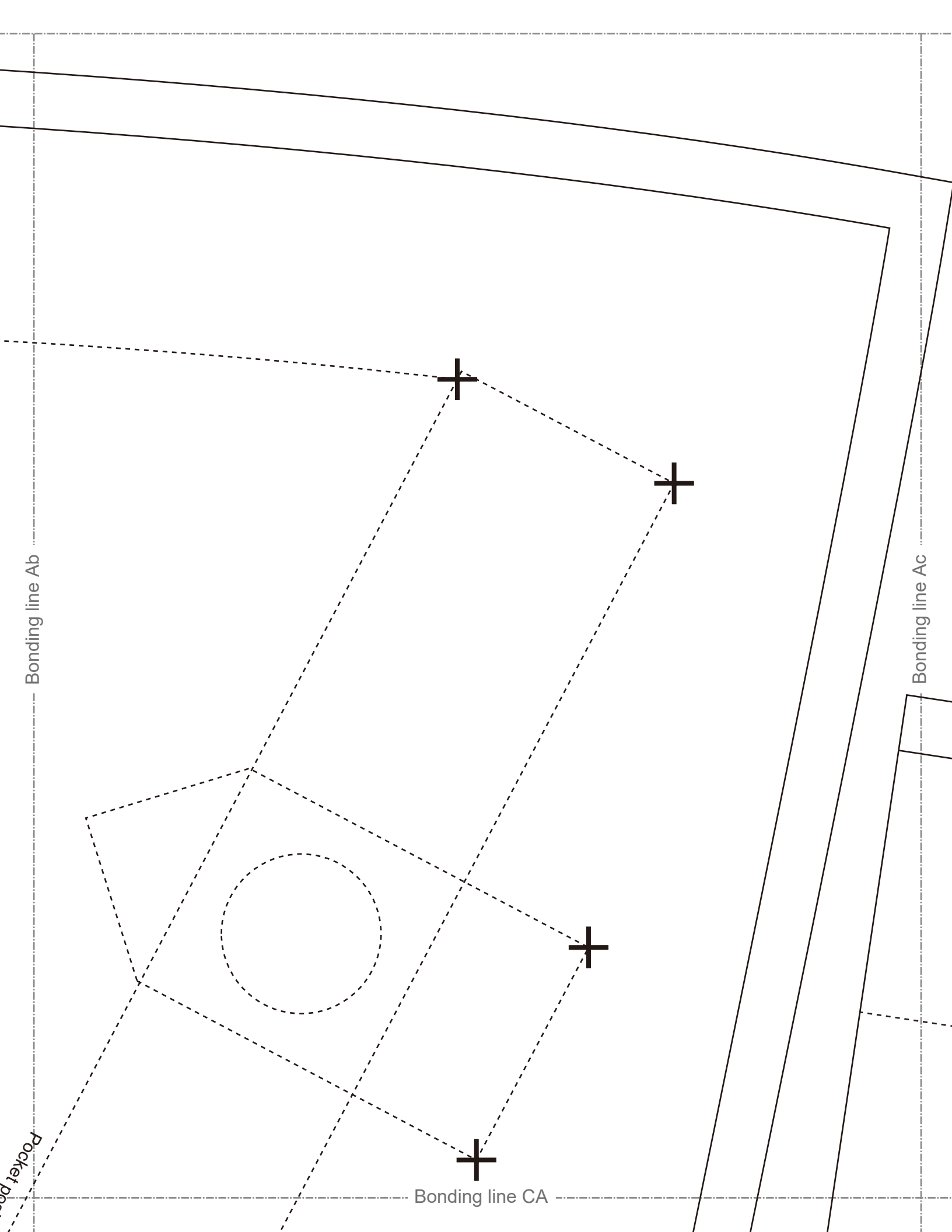

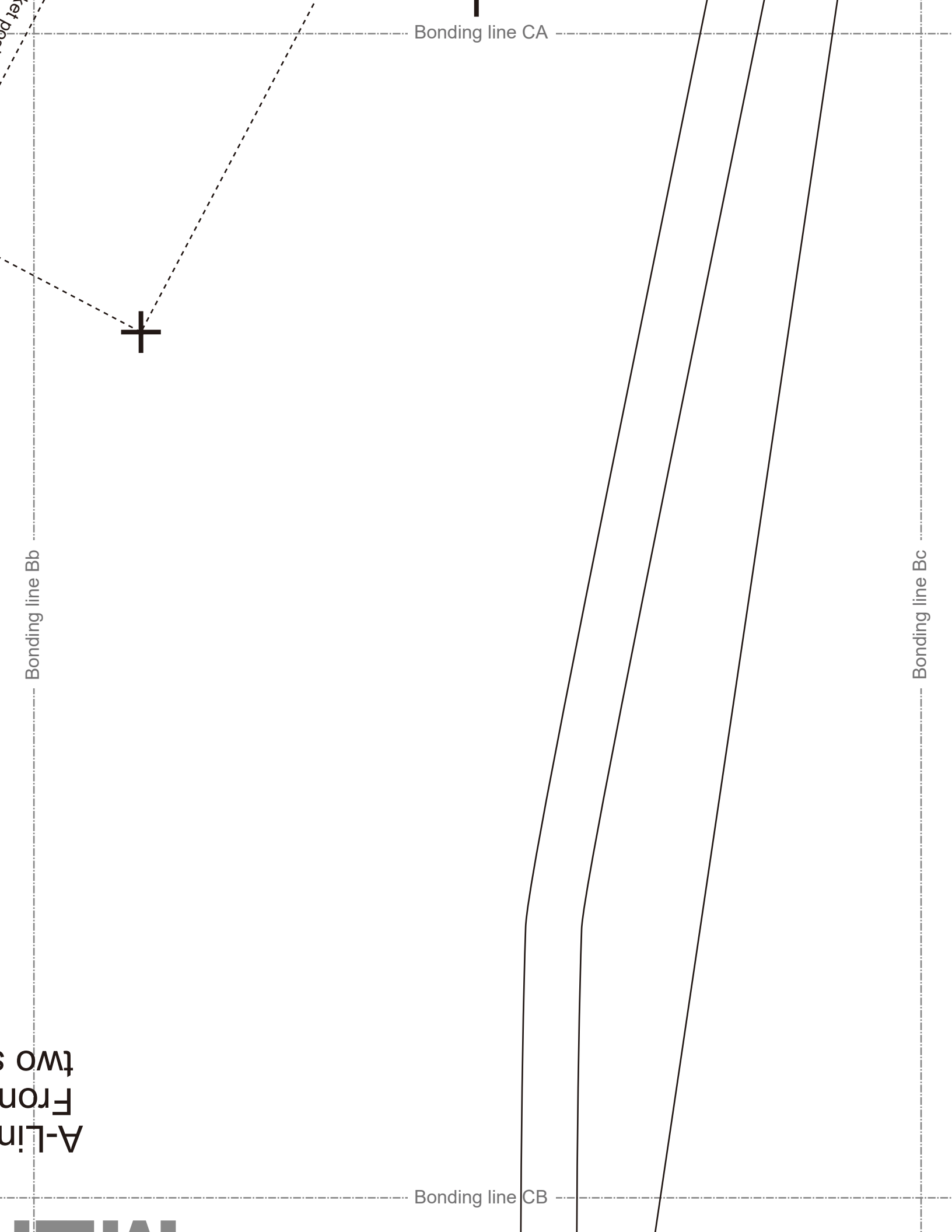

MEN

Bonding line CB

Bonding line Cb

Bonding line CC

Bonding line Cc



Bonding line CC

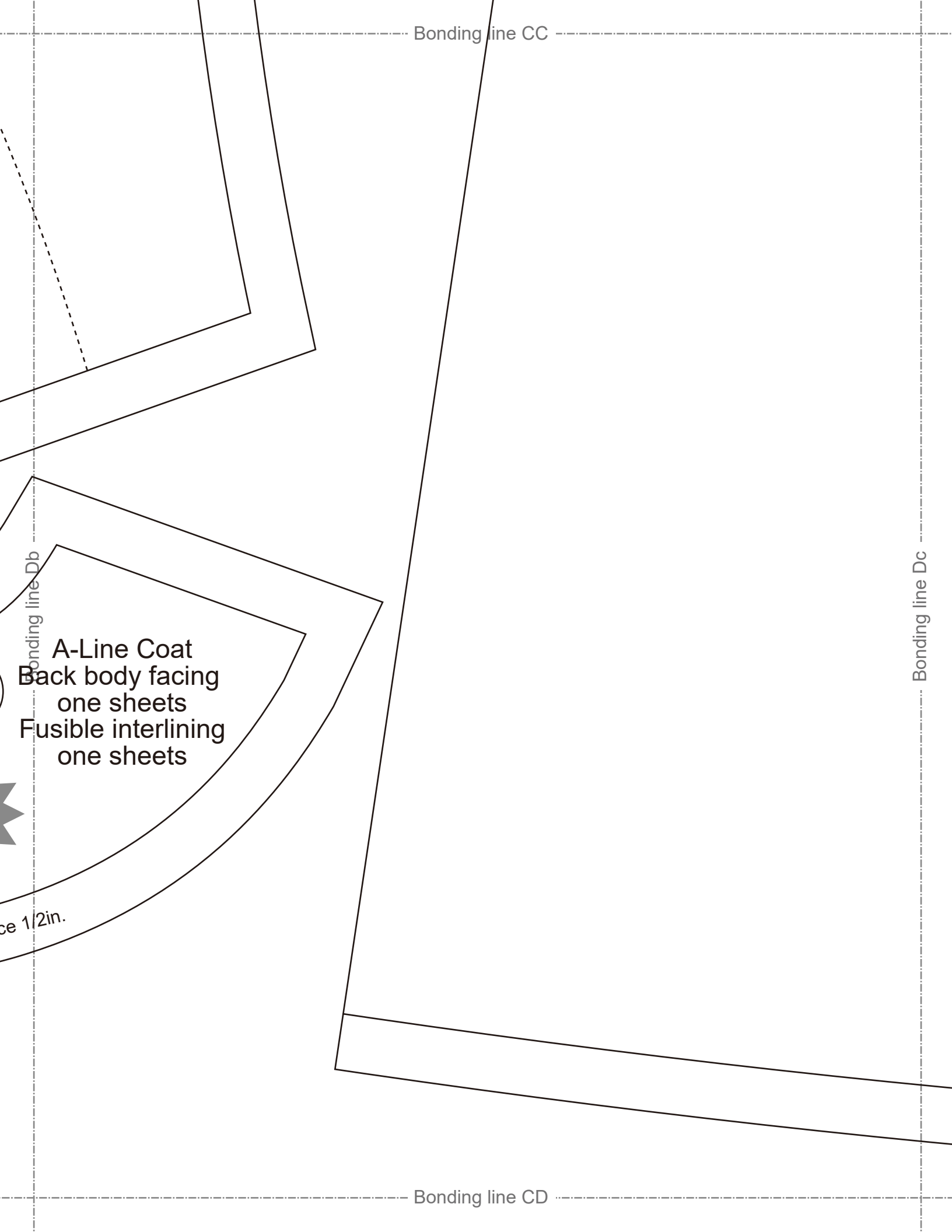

A-Line Coat
Back body facing
one sheets
Fusible interlining
one sheets

ce 1/2in.

Bonding line CD

Bonding line Dc

A-Line Coat Pocket parts two sheets

M

Grain Line

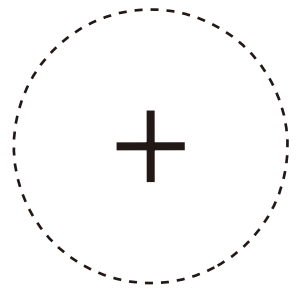

Seam allowance 1/2in.

Bonding line Ac

Bonding line Ad

Facing Line

Bonding line DA

DRCOS

SITE [http://dr-cos.info\(en\)](http://dr-cos.info(en)) [http://dr-cos.com\(jp\)](http://dr-cos.com(jp))
MAIL info@dr-cos.com
Twitter [@drcos_com](https://twitter.com/@drcos_com)
facebook <https://www.facebook.com/drcoscom>

Bonding line DA

Bonding line Bc

Bonding line Bd

MEN'S  **size**

Bonding line size

MENS  size

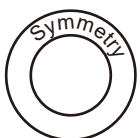

A-Line Coat
Back body
two sheets

Bonding line Cc

Bonding line Cd



Bonding line DC

Bonding line DC

Strain Line



Bonding line Dc

Bonding line Dd

Seam allowance 1/2in.

Bonding line DD

MEN'S  size

**DRCOS**

SITE [http://dr-cos.info\(en\)](http://dr-cos.info(en)) [http://dr-cos.com\(jp\)](http://dr-cos.com(jp))
MAIL info@dr-cos.com
Twitter [@drcos_com](https://twitter.com/@drcos_com)
facebook <https://www.facebook.com/drcoscom>

Bonding line Ad



Bonding line Ae

s.com(jp)
n
rcoscom

Bonding line EA

Bonding line EA

Bonding line Bd

Bonding line Be

Bonding line EB

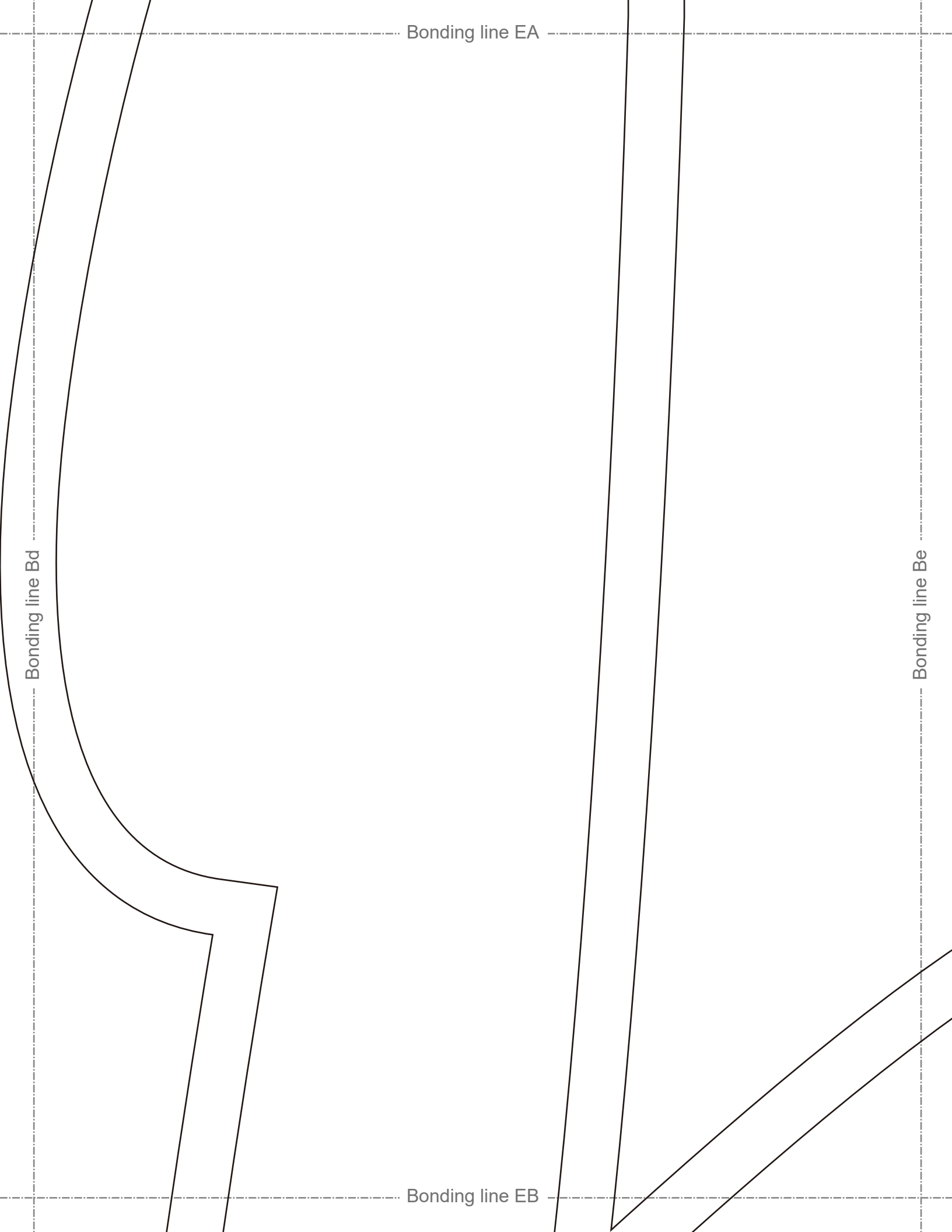

Bonding line Cd

Bonding line EB

A-Line Coat
sleeve belt(A)
two sheets

Bonding line EC



SITE <http://dr-cos.info/en> <http://dr-cos.com/jp>
MAIL info@dr-cos.com
Twitter <https://twitter.com/drcos.com>
facebook <https://www.facebook.com/drcos.com>

Seam allowance 1/2in.

Bonding line Ce

Bonding line EC

M

Grain Line



Bonding line Dd

Bonding line De

A-Line C
sleeve be
two she

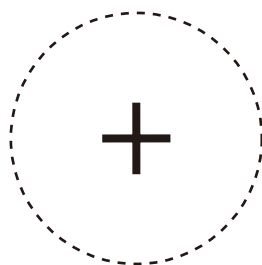

MEN

DRCOS

SITE [http://dr-cos.info\(en\)](http://dr-cos.info(en)) [http://dr-cos.com\(jp\)](http://dr-cos.com(jp))
MAIL info@dr-cos.com
Twitter https://twitter.com/@drcos_com
facebook <https://www.facebook.com/drcoscom>

Seam allowance 1.

Bonding line ED

Seam allowance 1/2in.



Belt threading position



Bonding line Ae

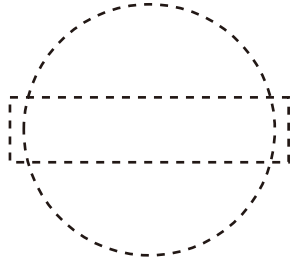

Sleeve belt position

Bonding line Af



Grain Line

Bonding line FA

Bonding line FA



A-Line Coat
Sleeve
two sheets



Bonding line Be

Bonding line Bf

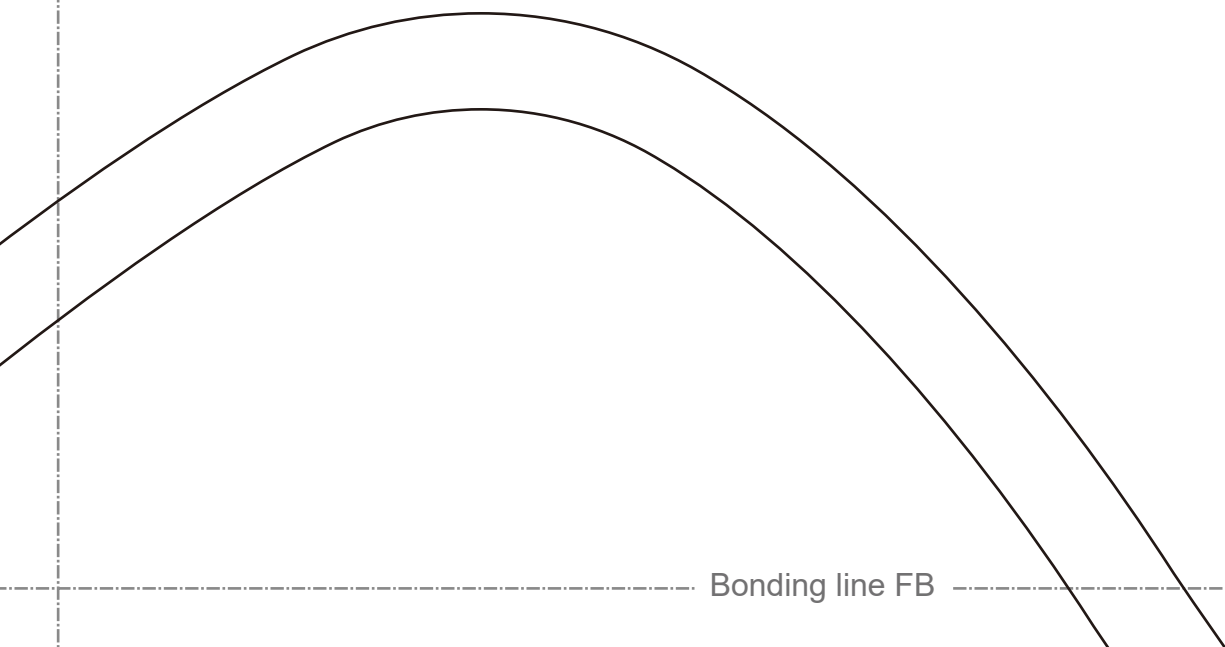

Bonding line FB

Bonding line FB

Bonding line Ce

Bonding line Cf

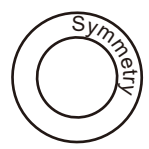
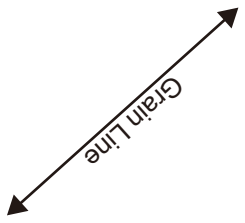
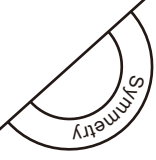

A-Line Coat
two sheets
Fusible interlining
one sheets

A-Line Coat
neckband

Bonding line FC

A-Line Coat
pocket band
two sheets

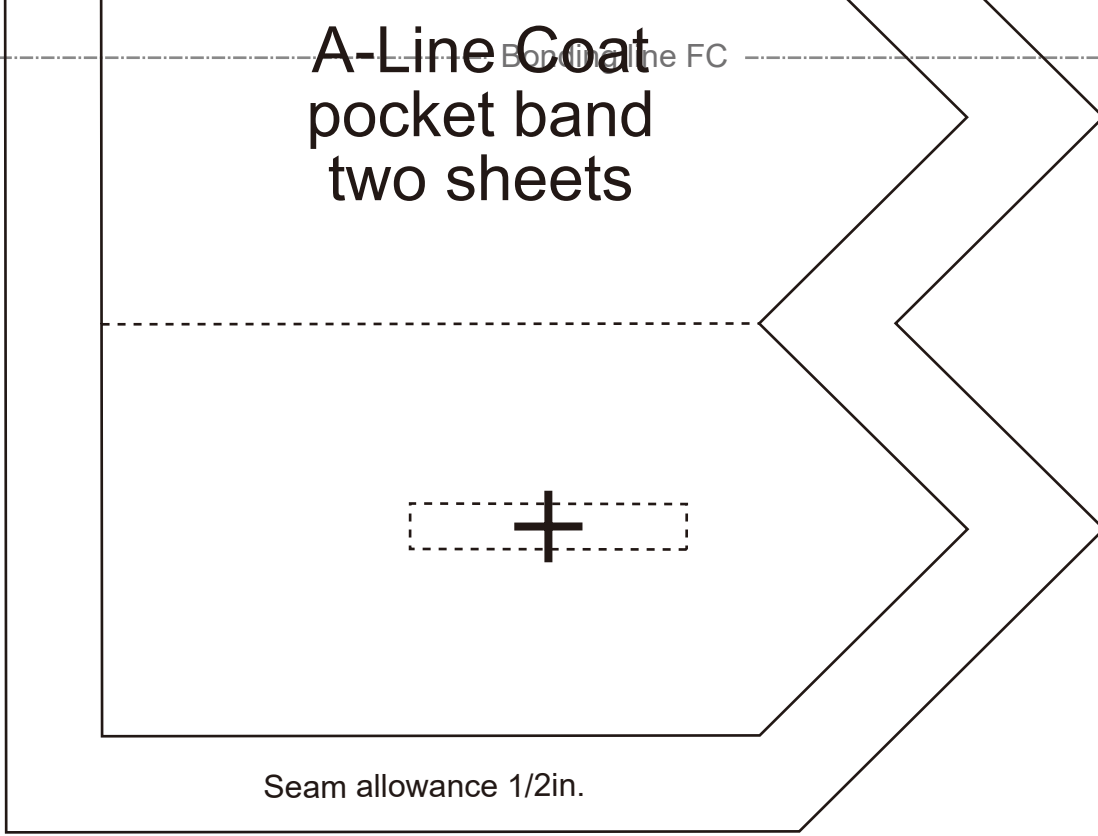

Seam allowance 1/2in.

A-Line Coat
Belt(B)
sheets

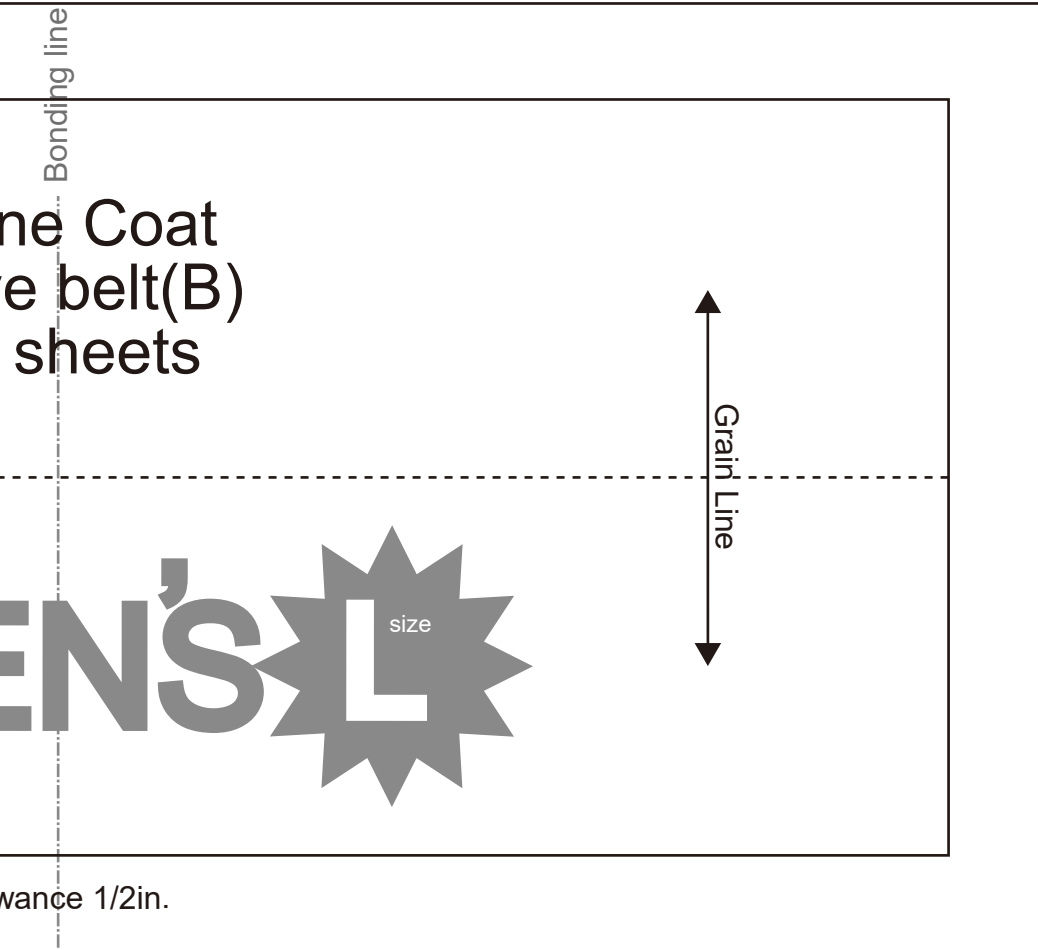

Seam allowance 1/2in.

Bonding line FD

Bonding line Df

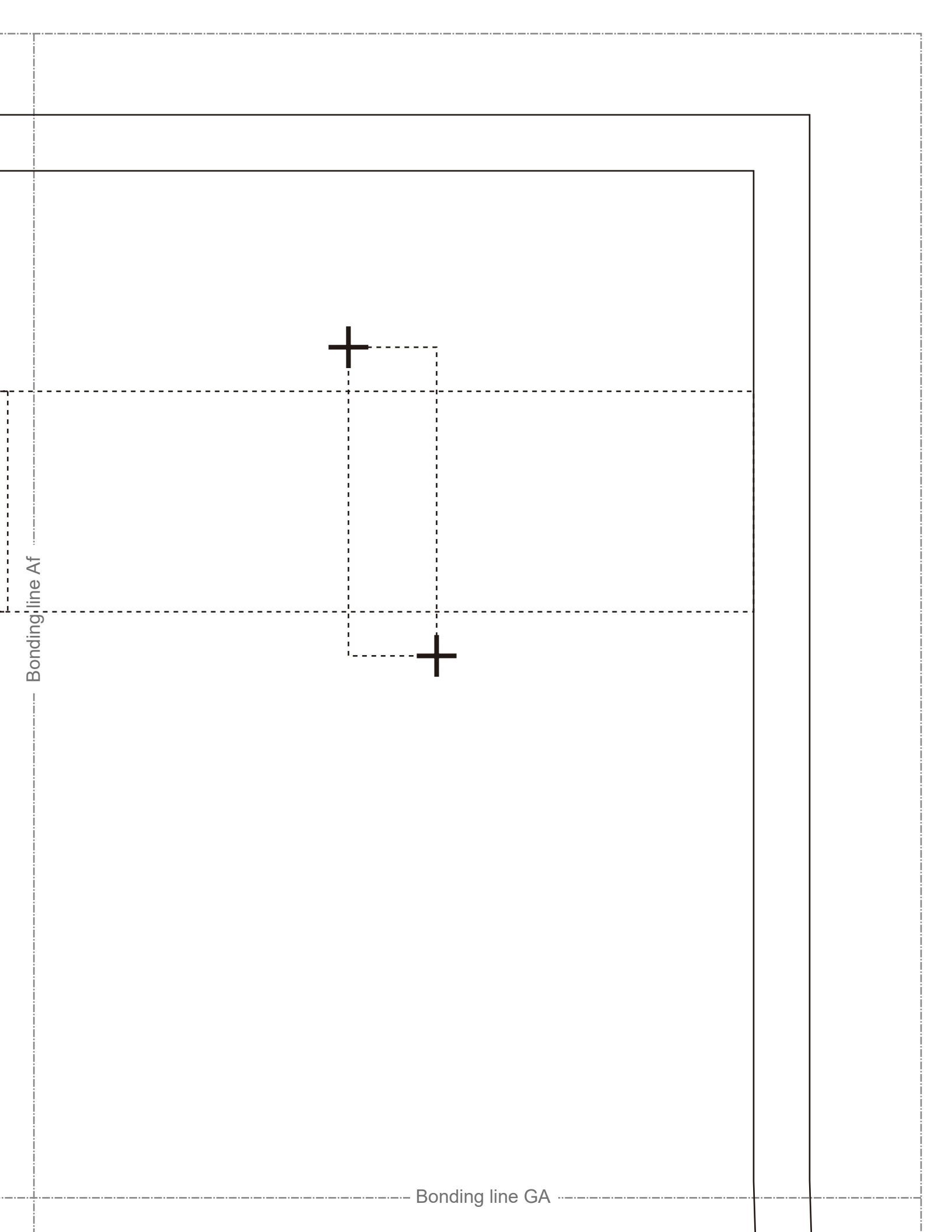

Bonding line Af

Bonding line GA

Bonding line GA

W

Bonding line Bf

Bonding line GB

Bonding line GB

DRCOS
SITE [http://dr-cos.info\(en\)](http://dr-cos.info(en)) [http://dr-cos.com\(jp\)](http://dr-cos.com(jp))
MAIL info@dr-cos.com
Twitter https://twitter.com/dr-cos_com
facebook <https://www.facebook.com/drcoscom>

Bonding line Cf

DRCOS

SITE [http://dr-cos.info\(en\)](http://dr-cos.info(en)) [http://dr-cos.com\(jp\)](http://dr-cos.com(jp))
MAIL info@dr-cos.com
Twitter https://twitter.com/dr-cos_com
facebook <https://www.facebook.com/drcoscom>

MEN'S

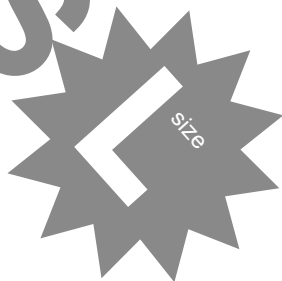

Bonding line GC

Bonding line GC

DRCOS

SITE [http://dr-cos.info\(en\)](http://dr-cos.info(en)) [http://dr-cos.com\(jp\)](http://dr-cos.com(jp))
MAIL info@dr-cos.com
Twitter https://twitter.com/drcos_com
facebook <https://www.facebook.com/drcoscom>

Bonding line Df

MEN'S  **L** size



**A-Line Coat
Pocket
two sheets**

Seam allowance 1/2in.

Bonding line GD