

DRCOS

SITE [https://dr-cos.info\(en\)](https://dr-cos.info/en) <https://dr-cos.info/jp>
MAIL info@dr-cos.com
Twitter [@drcos_com](https://twitter.com/@drcos_com)
pinterest <https://www.pinterest.jp/drcosinfo>

Bonding line Aa

Bonding line AA

Bonding line AA

LADIES

Bonding line Ba

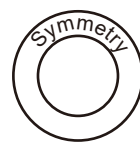

Waistmantl
Front Bodi
cut one



Bonding line AB

Bonding line AB

Bonding line Ca

Length Line

Bonding line AC

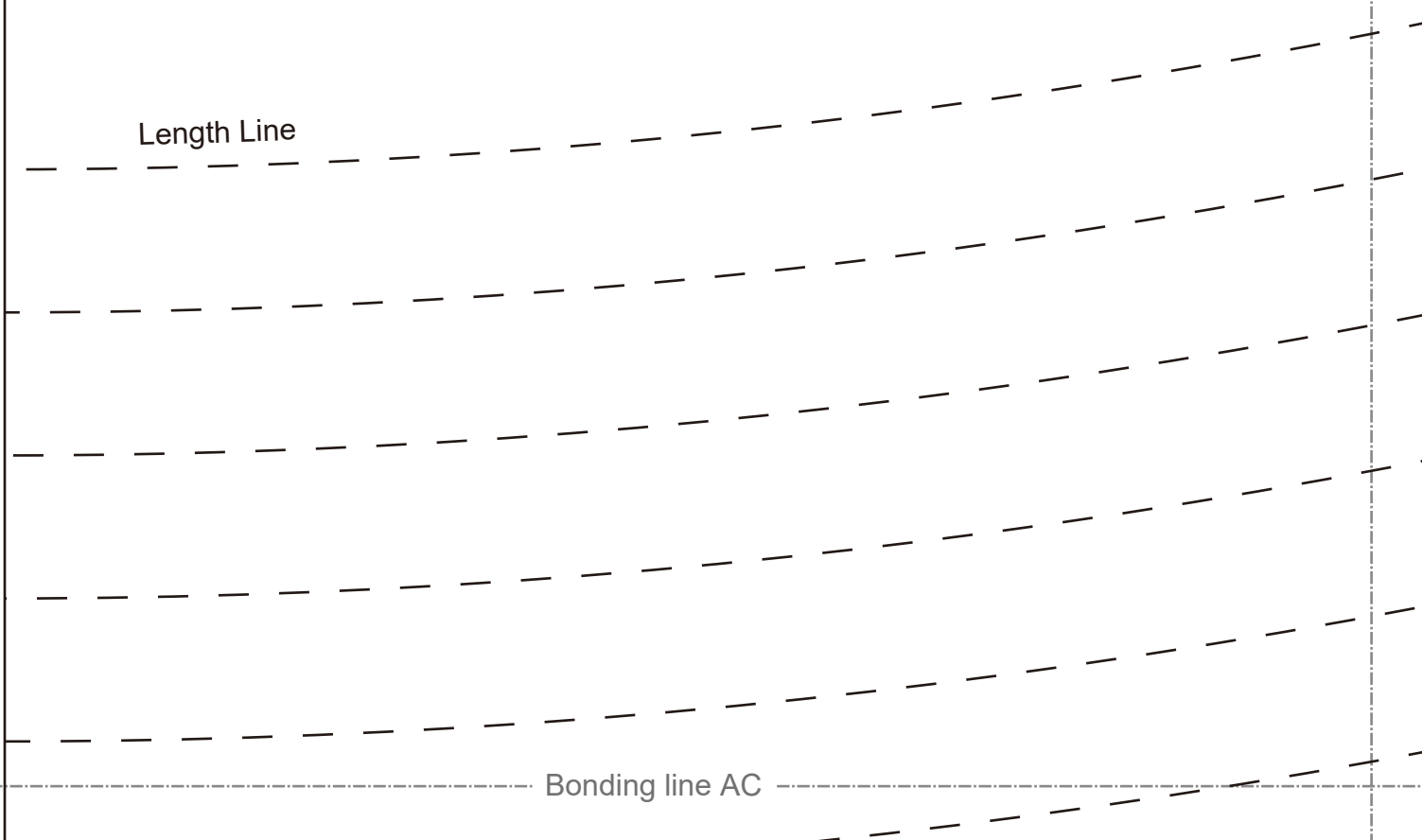

Bonding line AC

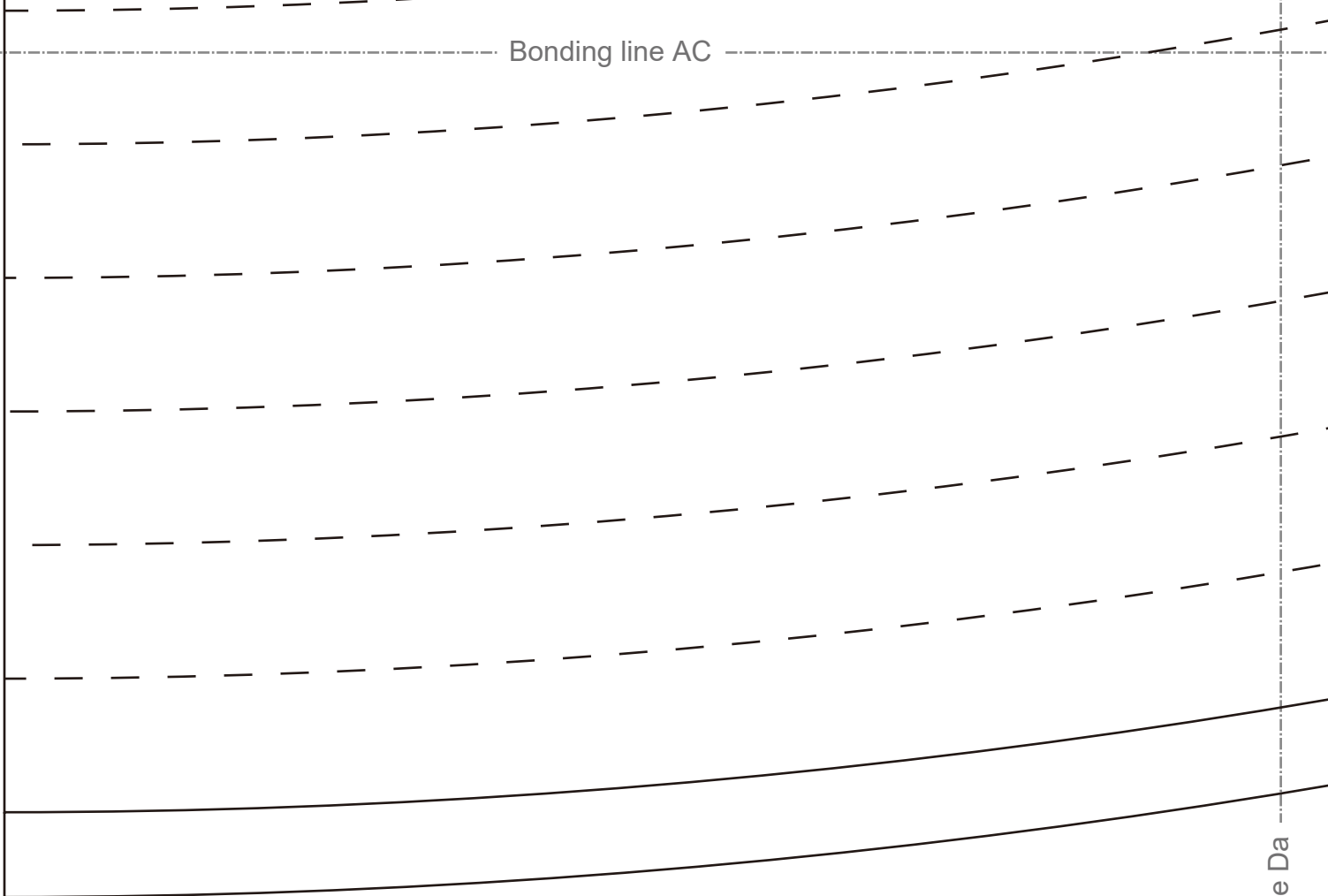

Bonding line Da

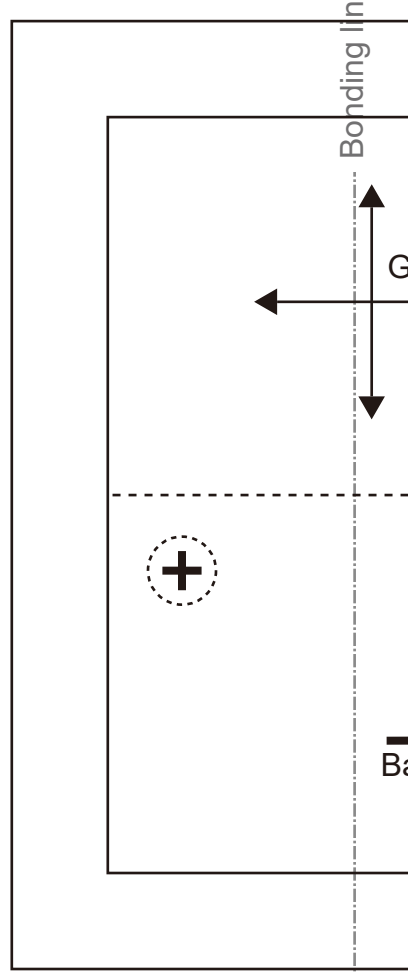

Ba

OS

h) <https://dr-cos.com/jp>

@drcos.com
erest.jp/drcosinfo

Bonding line Aa

Bonding line Ab

Bonding line BA

Bonding line BA

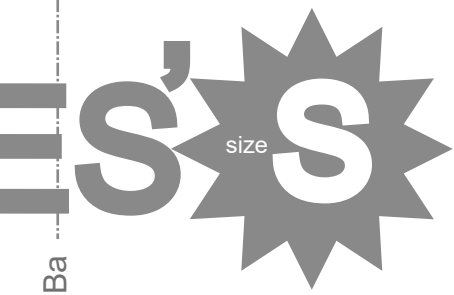

Bonding line Ba

Mantle II
Bodice
one

Bonding line Bb



Bonding line BB

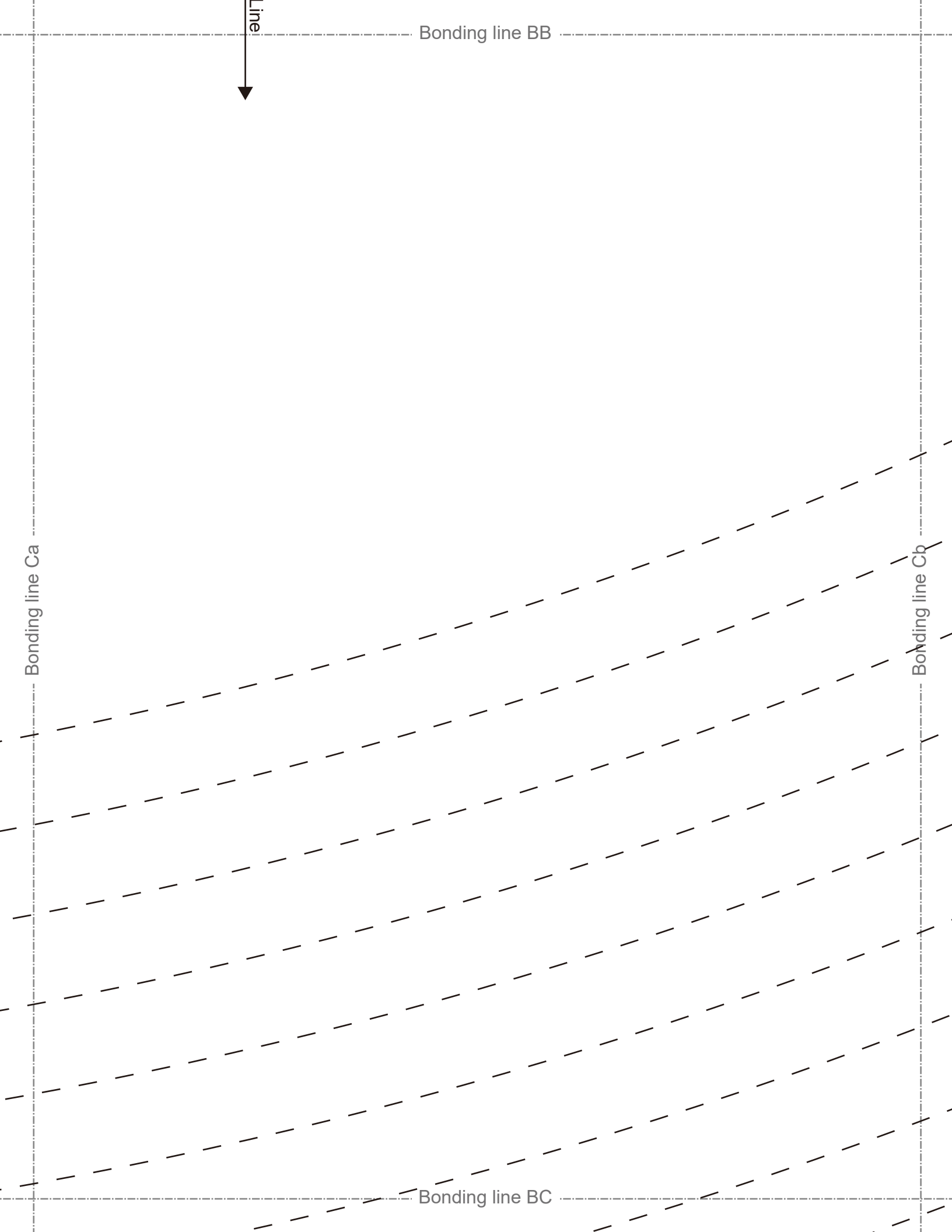

Bonding line BC

Seam allowance 1/2in.

Bonding line Da

Bonding line Db

Grain Line

LADIES' size

Baste



Waistmantle II
Waist band
Fusible interlining
cut one

Seam allowance 1/2in.

Bonding line CA

Bonding line Bb

Bonding line Bc

Bonding line CB



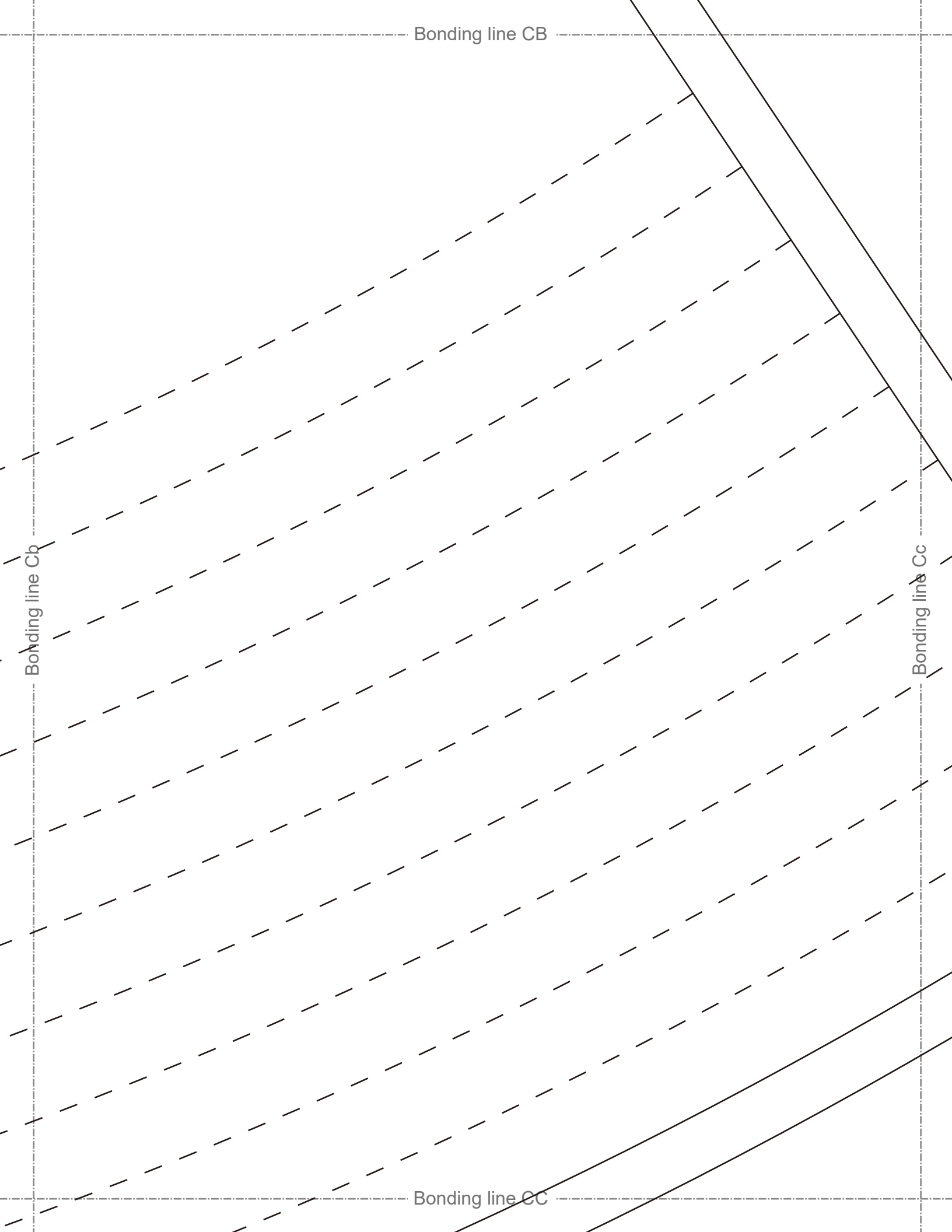

Bonding line CB

Bonding line Cb

Bonding line CC

Bonding line Cc

Bonding line CC

Bonding line Db

Bonding line Dc

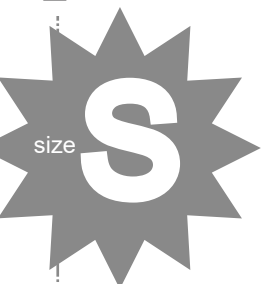

DRCOS
 SITE <https://dr-cos.info/en> <https://dr-cos.com/jp>
 MAIL info@dr-cos.com
 Twitter https://twitter.com/@drcos_com
 pinterest <https://www.pinterest.jp/drcosinfo>

Bend line



ng

Bonding line DB

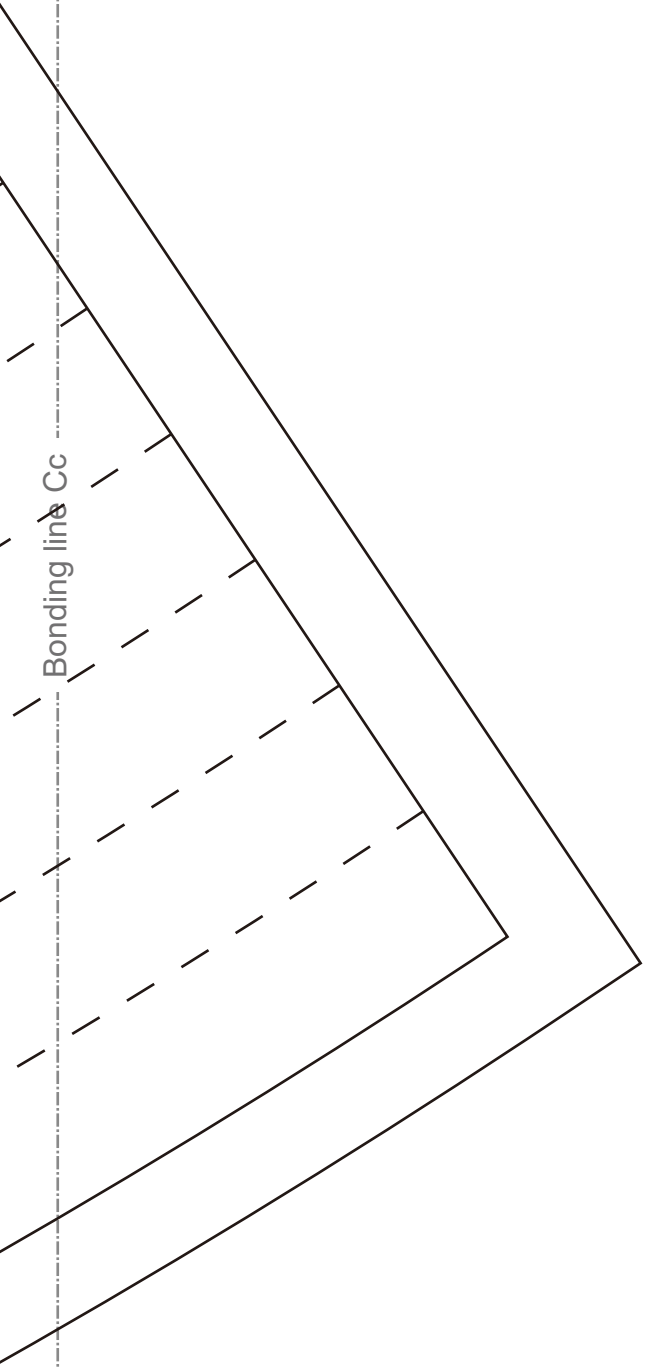

Bonding line Cc

Bonding line Cd

Bonding line DC