

[Home](#)

[Back to Tshirt3 page](#)



Bonding line AA

Bonding line Aa

Bonding line AA



Tshirt3
Back Body
one sheets



MEN'S
T
size

Bonding line Ba

Bonding line AB

Bonding line AB

Bonding line Ca

Bonding line AC

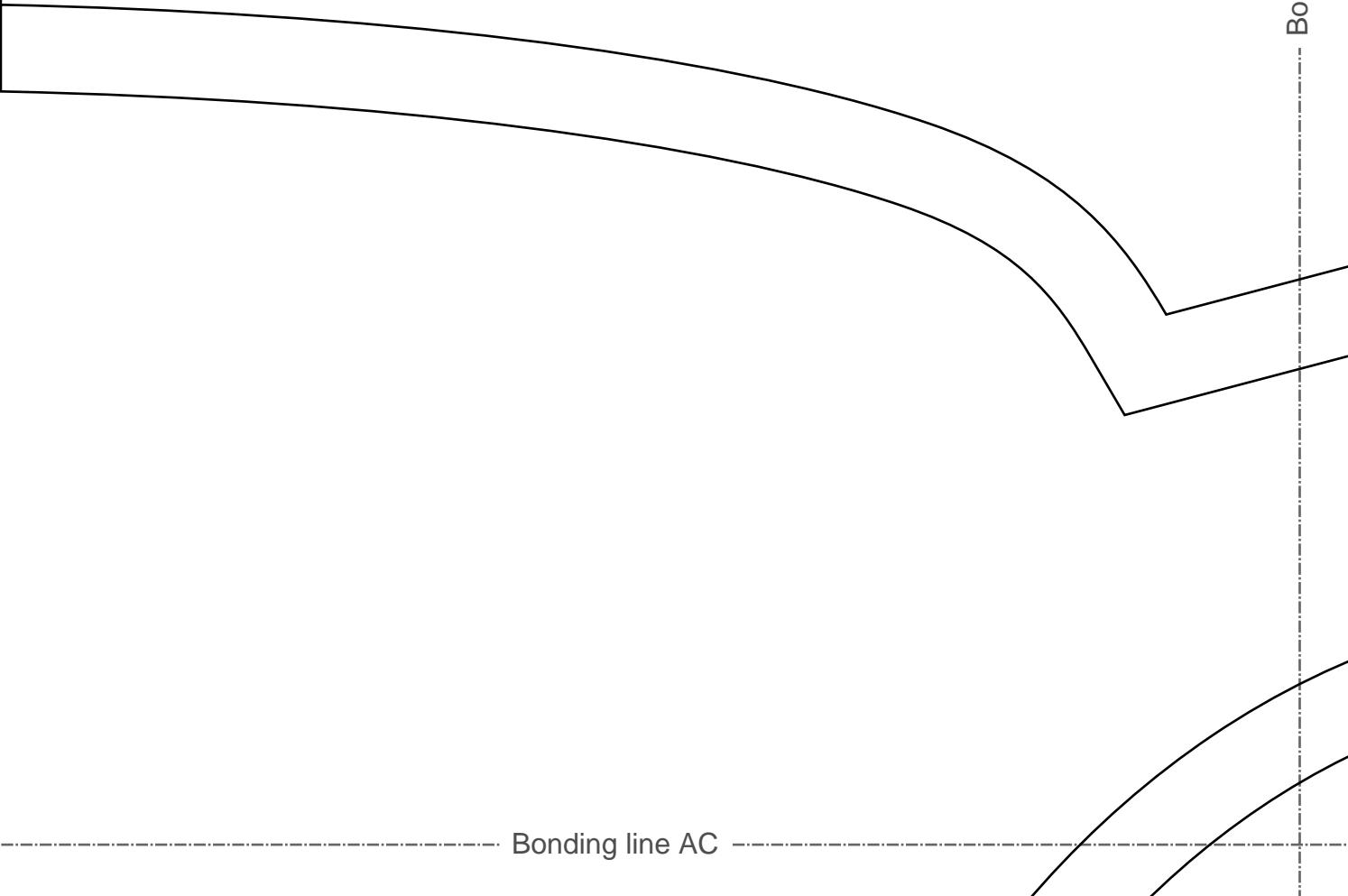

Bonding line AC

Front

Grain Line

Bonding line Da

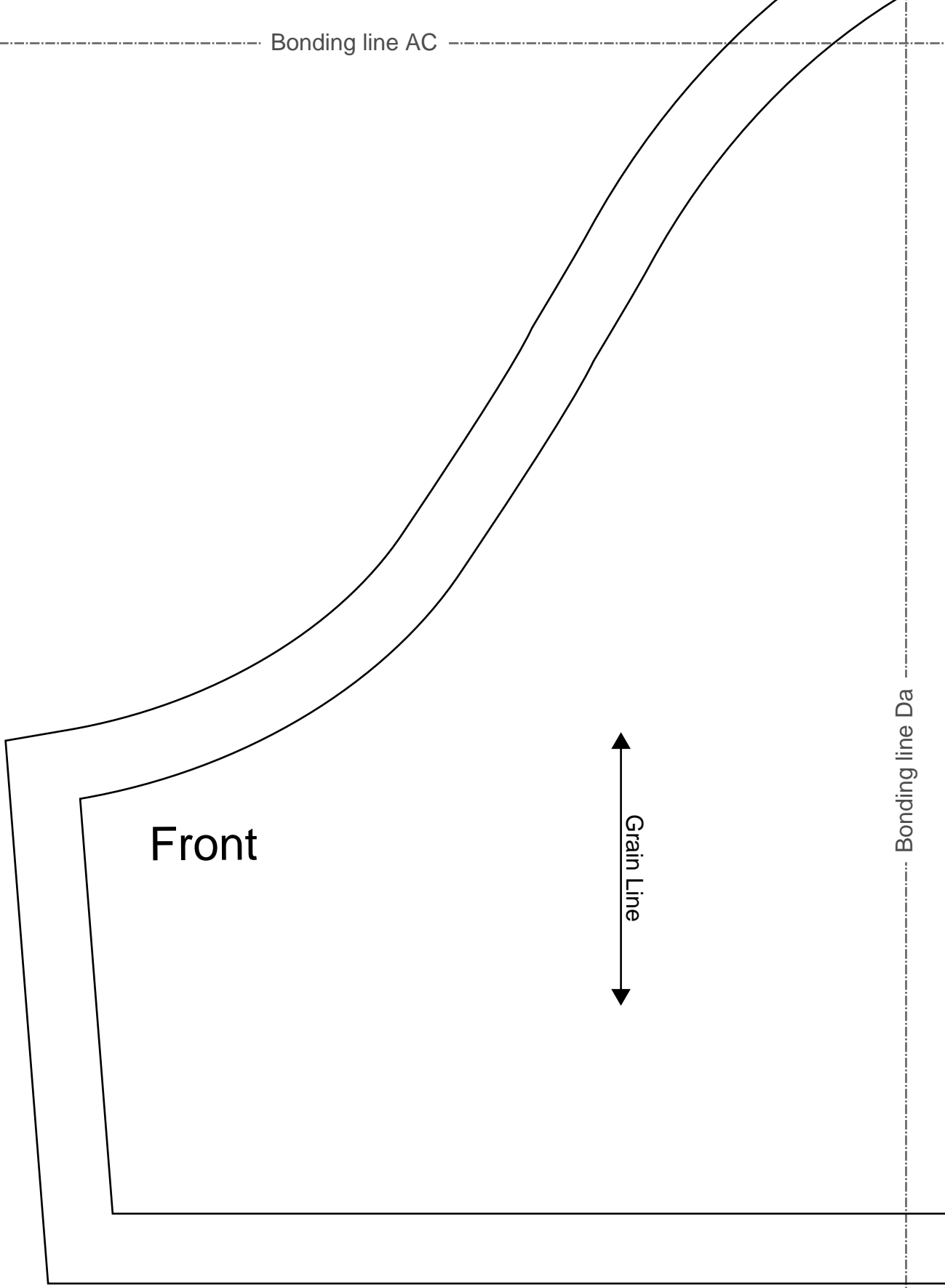

Bonding line Aa

DRCOS
SITE <http://dr-cos.info/en> <http://dr-cos.com/jp>
MAIL info@dr-cos.com
Twitter https://twitter.com/drcos_com
facebook <https://www.facebook.com/drcoscom>

u.

Bonding line B

Seam allow

DRCOS
SITE <http://dr-cos.info/en> <http://dr-cos.com/jp>
MAIL info@dr-cos.com
Twitter https://twitter.com/drcos_com
facebook <https://www.facebook.com/drcoscom>

Bonding line Ab

Bonding line Ba

Bonding line Bb

Seam allowance 1/2in.

Seam allowance 1/2in.

Bonding line Bb

Bonding line BB

Bonding line BB

Bonding line Ca

Bonding line Cb

DRCOS

SITE [http://dr-cos.info\(en\)](http://dr-cos.info(en)) [http://dr-cos.com\(jp\)](http://dr-cos.com(jp))

MAIL info@dr-cos.com

Twitter https://twitter.com/@drcos_com

facebook <https://www.facebook.com/drcos.com>

Bonding line BC

DRCOS

SITE [http://dr-cos.info\(en\)](http://dr-cos.info(en)) [http://dr-cos.com\(jp\)](http://dr-cos.com(jp))
MAIL info@dr-cos.com
Twitter https://twitter.com/drcos_com
facebook <https://www.facebook.com/drcoscom>

Bonding line BC

MEN'S  size

Tshirt3
Sleeve
two sheets

Bonding line Da

Bonding line Db

Seam allowance 1/2in.

Bonding line Ab

Bonding line Ac

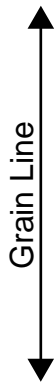

Bonding line CA

Bonding line CA

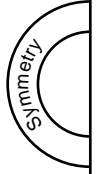

Tshirt3
Front Body
one sheets



Bonding line Bb

MEN'S
T
size

Bonding line Bc

Bonding line CB

Bonding line CB

Bonding line Cb

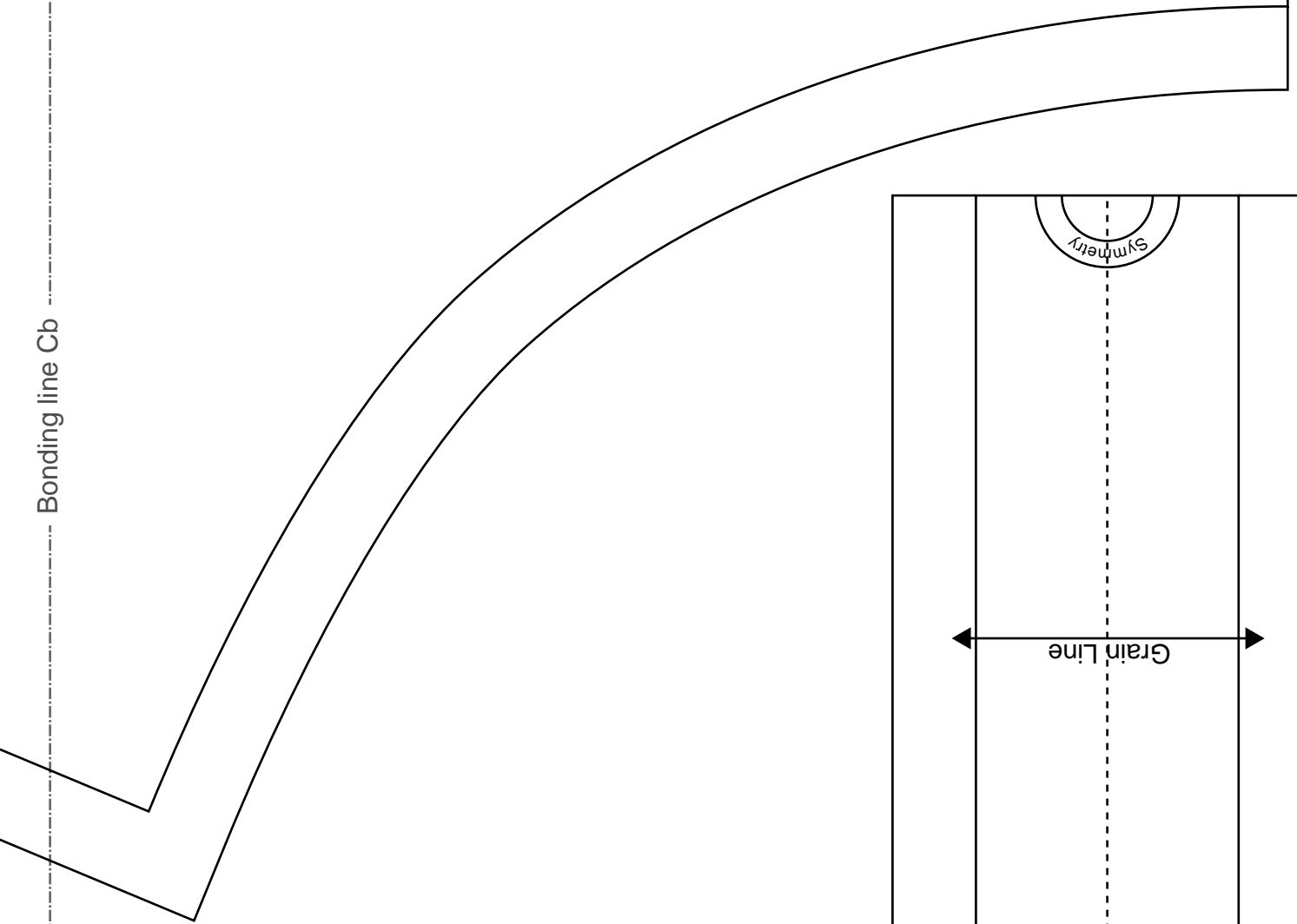

Bonding line CC

Bonding line Cc

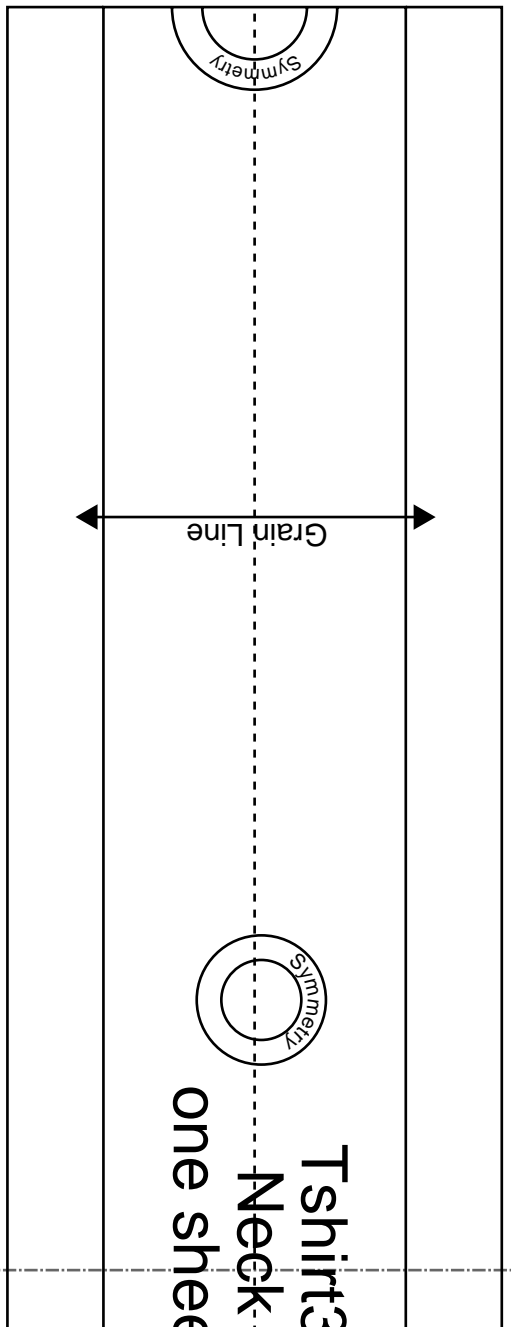

Tshirt3
Neck
one sheet

Grain Line

Symmetry

Symmetry

shirt
neck
sheets

Seam allowance 1/2in.

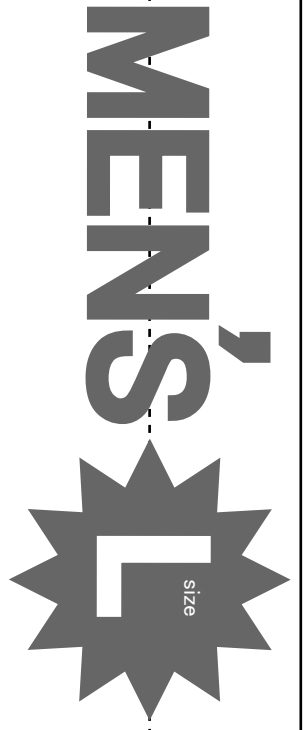

Size



DRCOS
SITE <http://dr-cos.info/en> <http://dr-cos.com/fr>
MAIL info@dr-cos.com
Twitter [@drcos.com](https://twitter.com/@drcos.com)
facebook <https://www.facebook.com/drcos.com>

Bonding line CC

Bonding line Db

Back

Bonding line Dc