

[Home](#)

[Back to Squareneckblouse page](#)

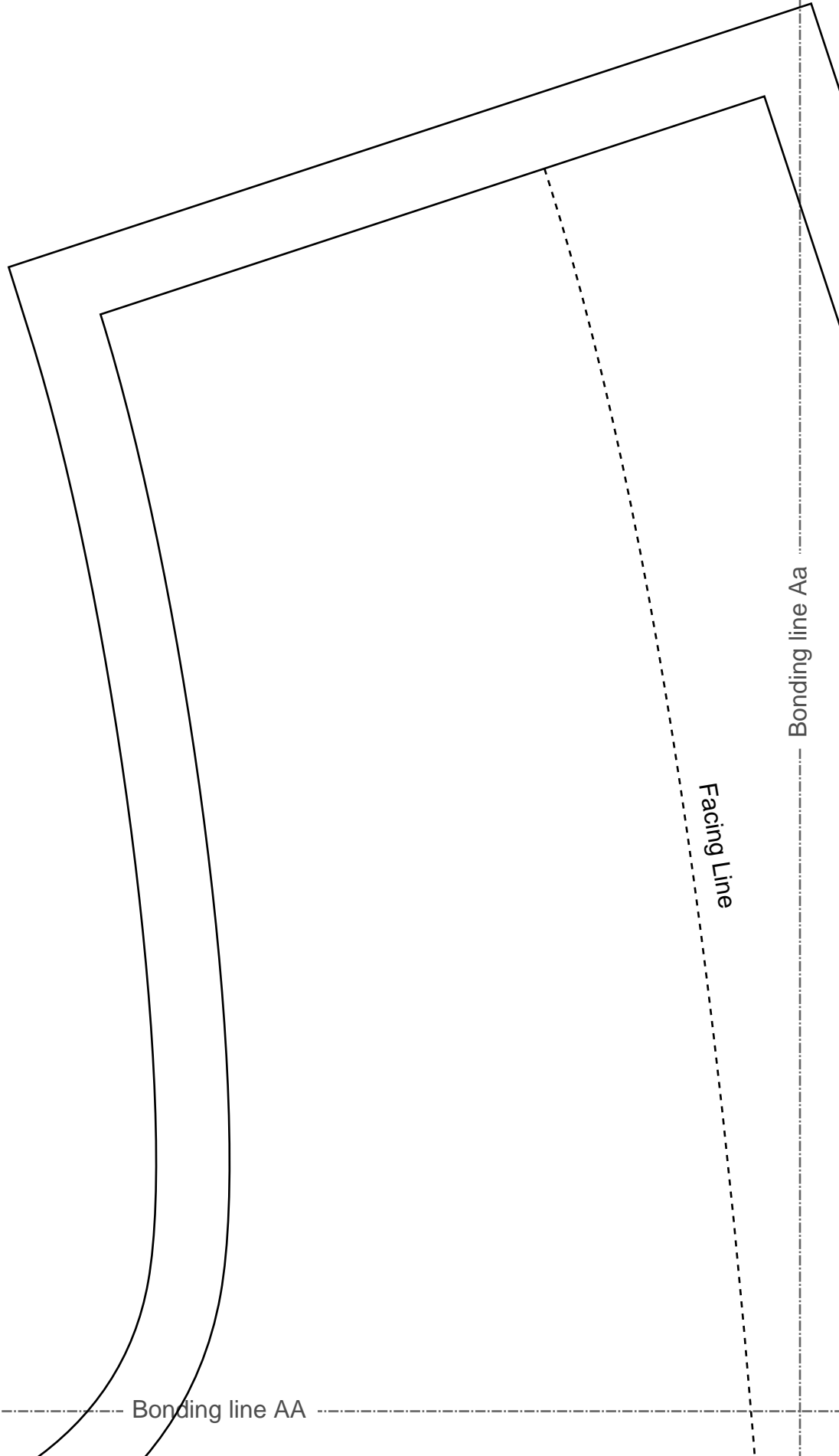

Bonding line AA

Bonding line Aa

Facing Line

Bonding line AA

**MEN'S** size **L**

Squar neck blouse2  
Front Body  
Two sheets

Bonding line Ba

Bonding line AB

Bonding line AB

Seam allowance 1/2in.

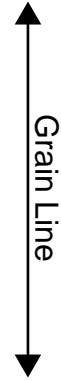

Bonding line Ca

**DRCOS**

SITE [http://dr-cos.info\(en\)](http://dr-cos.info(en)) [http://dr-cos.com\(jp\)](http://dr-cos.com(jp))

MAIL [info@dr-cos.com](mailto:info@dr-cos.com)

Twitter [@drcos\\_com](https://twitter.com/@drcos_com)

facebook <https://www.facebook.com/drcoscom>

Bonding line AC

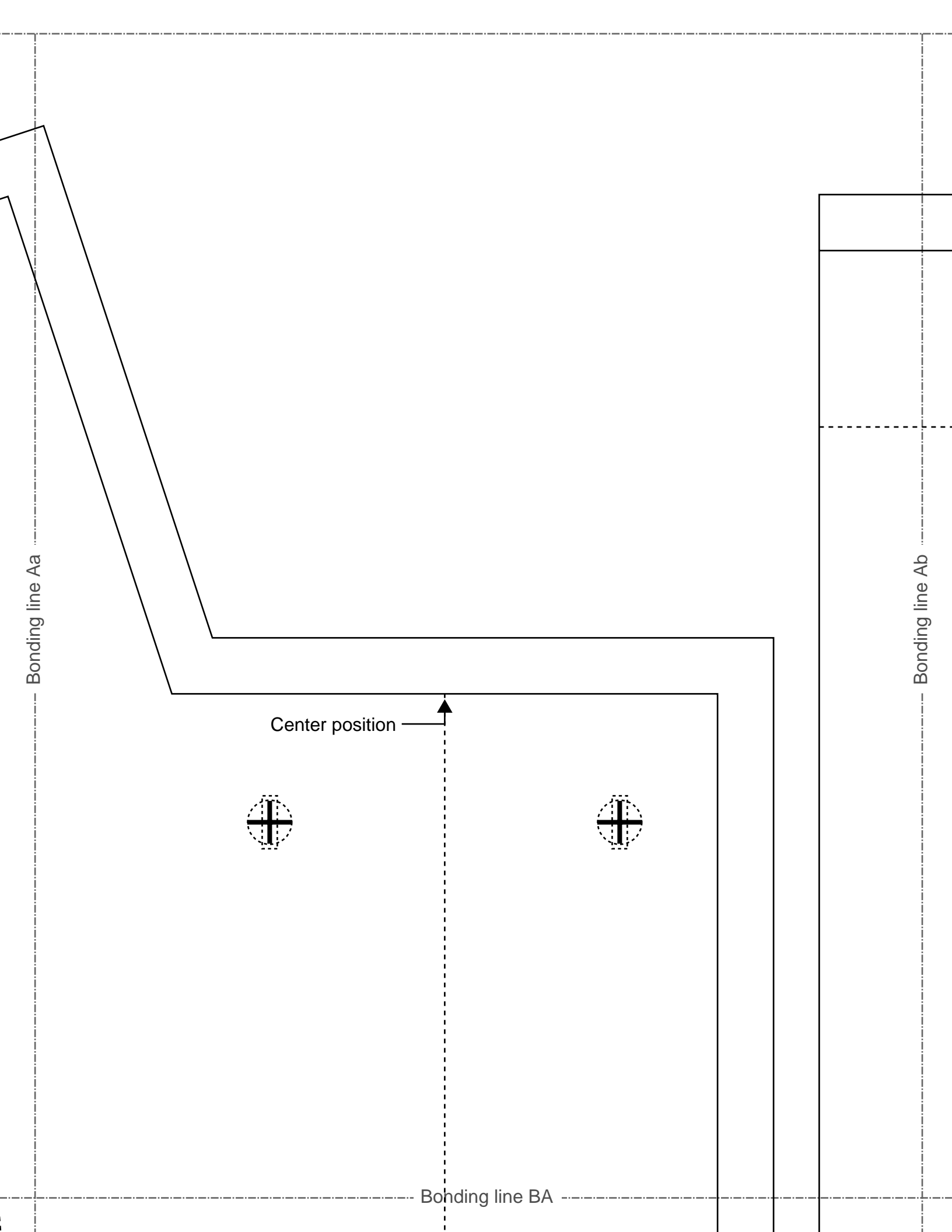

Bonding line BA

Baste

Bonding line Ba

Button position

Bonding line BB

Bonding line Bb

Symmetry

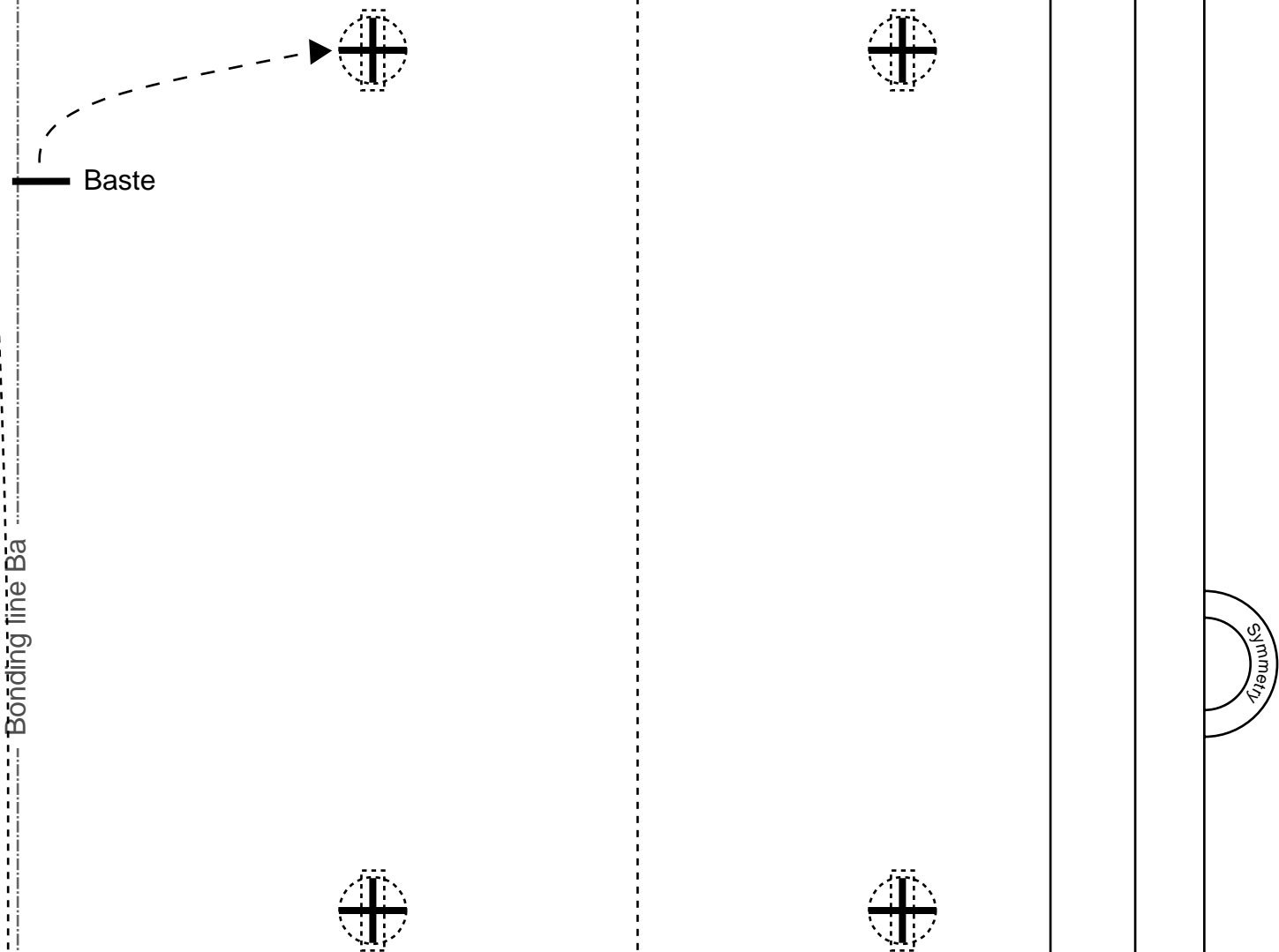

Bonding line BB



Bonding line Ca

Bonding line Cb

Bonding line BC

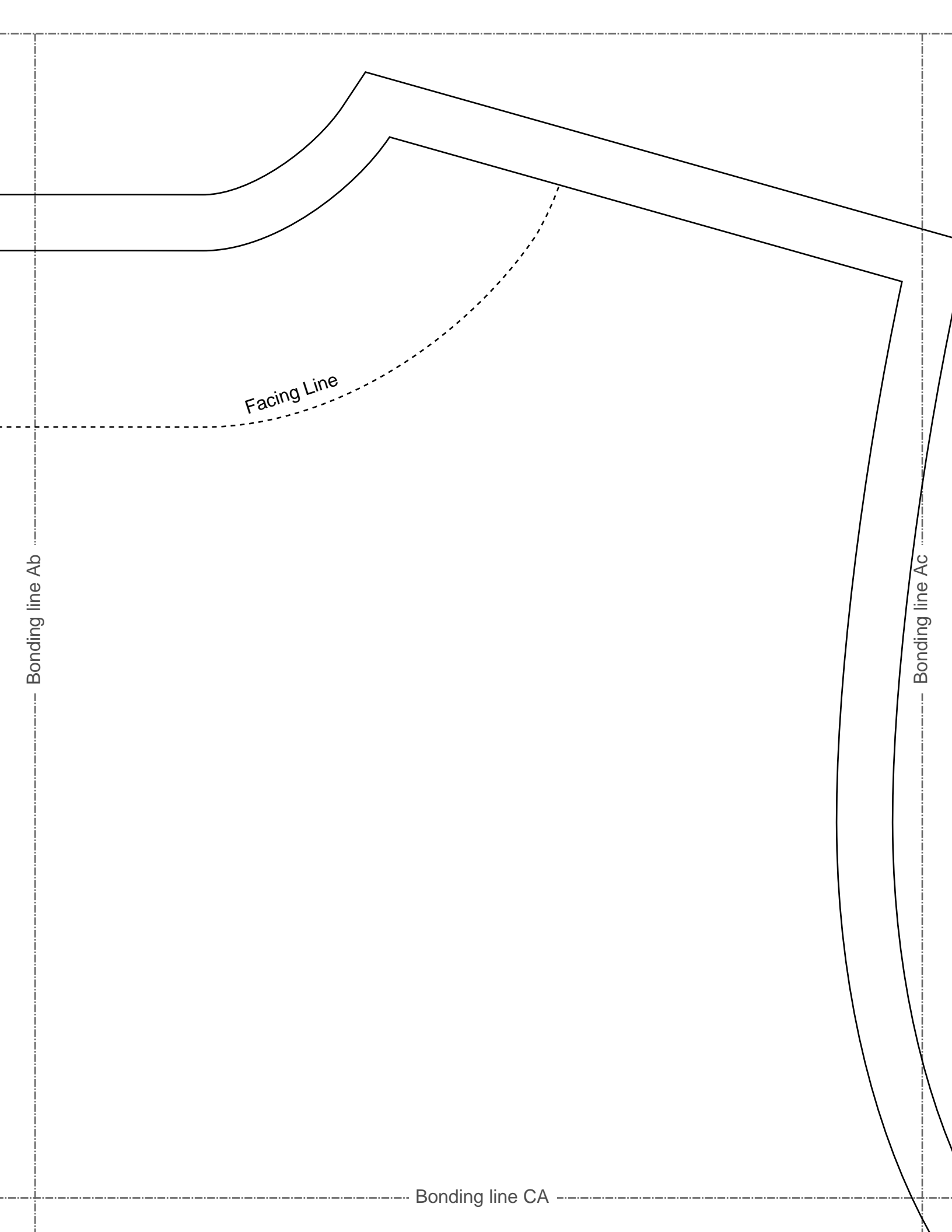

MEN'S size L

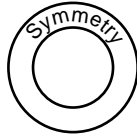

Squar neck blouse2  
Back Body  
one sheets





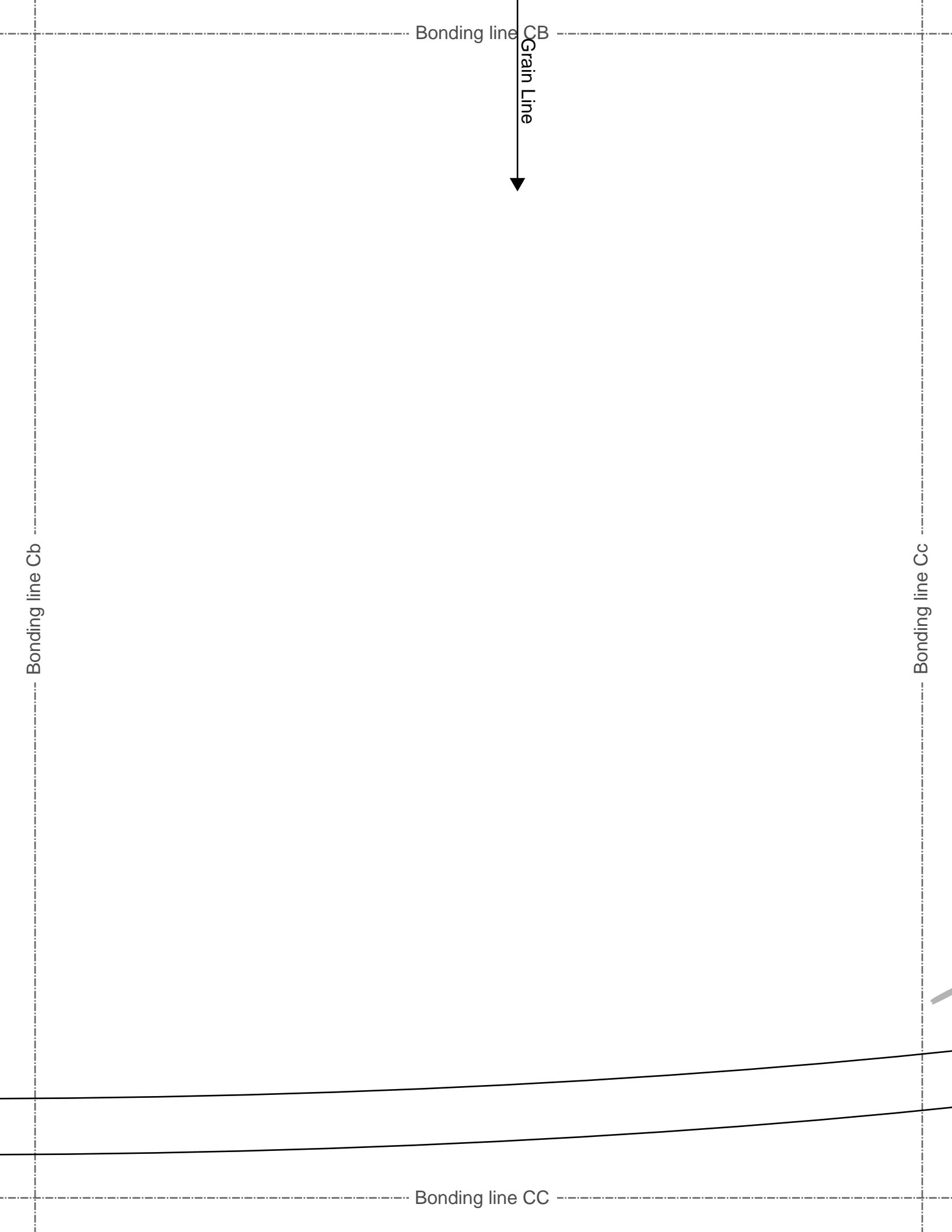

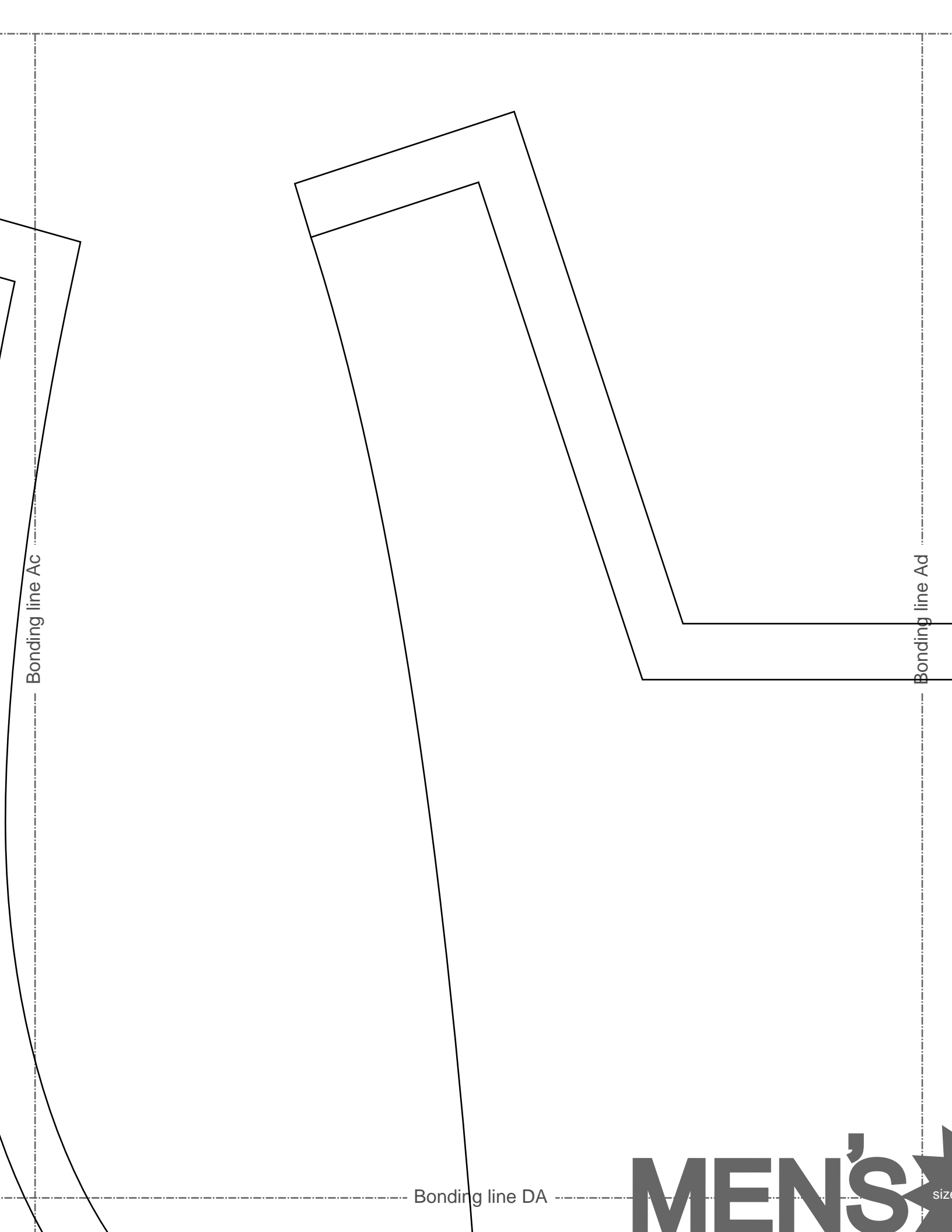

Bonding line Ac

Bonding line Ad

Bonding line DA

**MEN'S**  size

Bonding line DA

Bonding line Bc

Bonding line Bd

Squar neck blouse  
Facing two sheets  
Fusible interlining two

Bonding line DB

Bonding line DB

Bonding line Cc

Seam allowance 1/2in.

Grain Line

Bonding line Cd

**DRCOS**

SITE [http://dr-cos.info\(en\)](http://dr-cos.info(en)) [http://dr-cos.com\(jp\)](http://dr-cos.com(jp))  
MAIL [info@dr-cos.com](mailto:info@dr-cos.com)  
Twitter [https://twitter.com/@drcos\\_com](https://twitter.com/@drcos_com)  
facebook <https://www.facebook.com/drcoscom>

Bonding line DC



size

Bonding line Ad

Bonding line EA

neck blouse2  
two sheets  
lining two sheets

**DRCOS**  
SITE: <http://drcos.net/en> | <http://drcos.com/fp>  
MAIL: [info@drcos.com](mailto:info@drcos.com) | [twitter.com/drcos](mailto:twitter.com/drcos)  
FACEBOOK: <https://www.facebook.com/drcos.com>

Back

Bonding line Ae

blouse2  
sheets  
two sheets

Bonding line Bd

size

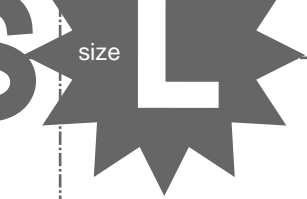

Bonding line EA

Seam allowance 1/2in.

Bonding line EB

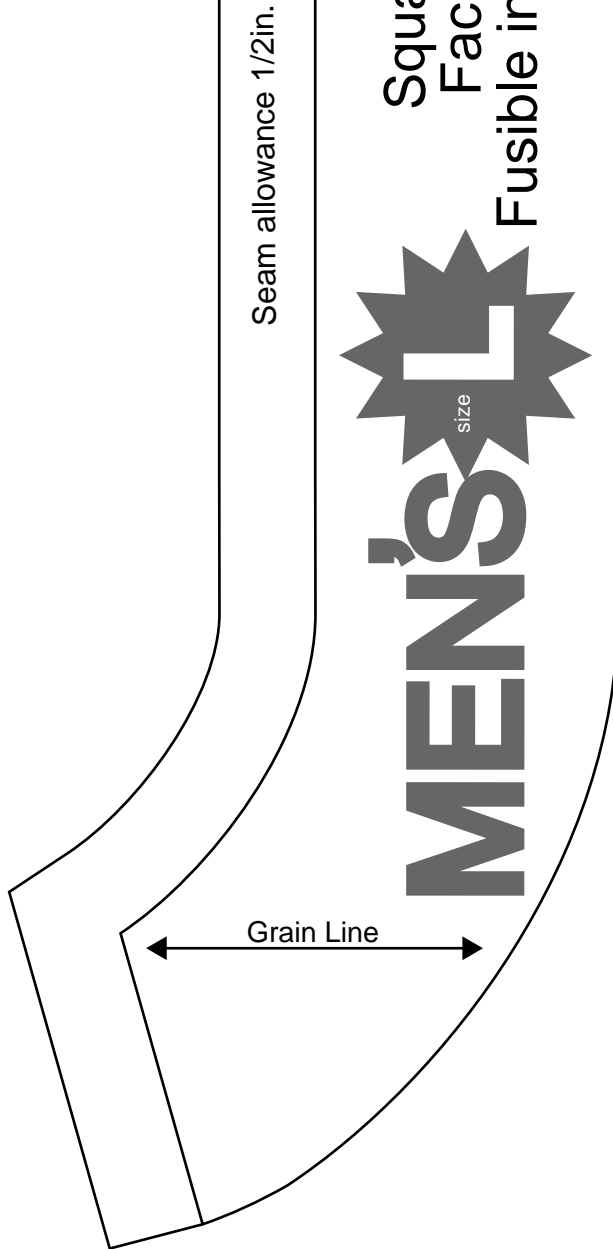

Seam allowance 1/2in.

Grain Line

Squar neck b  
Facing two  
Fusible interlining



size

**MEN'S**

Bonding line Be

Bonding line Cd

Seam

Bonding line EB

Bonding line Ce

**DRCOS**

SITE <http://dr-cos.info/en> <http://dr-cos.com/jp>

MAIL [info@dr-cos.com](mailto:info@dr-cos.com)

Twitter [https://twitter.com/drcos\\_com](https://twitter.com/drcos_com)

facebook <https://www.facebook.com/drcoscom>

Bonding line EC

Seam allowance 1/2in.

neck blouse?  
leeve  
sheets

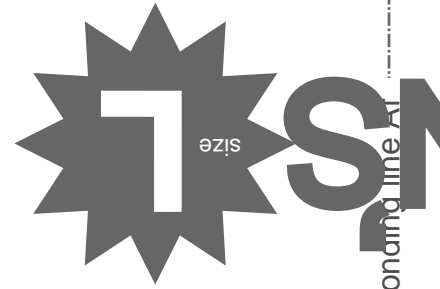

Grain Line

Bonding line Ae

Bonding line Al

facebook <https://www.facebook.com/drcoscom>  
Twitter [https://twitter.com/drcos\\_com](https://twitter.com/drcos_com)  
MAIL [info@drcos.com](mailto:info@drcos.com)  
SITE <http://drcos.info/en> [http://drcos.com\(fp\)](http://drcos.com(fp))



Bonding line FA



Squar neck  
Sleeve  
two she

Front

**MENS**

Bonding line A1

Bonding line GA

