

DRCOS
SITE <http://drcos.info/en> [http://drcos.com\(jp\)](http://drcos.com(jp))
MAIL info@drcos.com
Twitter <https://twitter.com/drcos> <https://www.facebook.com/drcos.com>
facebook <https://www.facebook.com/drcos.com>

Grain Line



Military Shirt
Front Bottom Body
Two sheets



Bonding line AA

Bonding line Aa

Bonding line AA

Facing Line

Bonding line Ba



Pocket position

Bonding line AB

Flap position



Bonding line AB

Flap position

Military Shirt Front Top Body Two sheets

Seam allowance 1/2in.

Facing Line

Grain Line

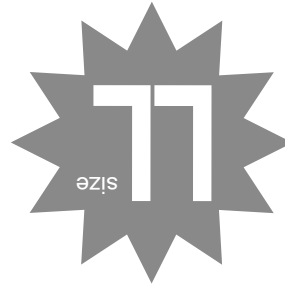

RCOS
Bc
p://dr-cos.info(en) http://dr-cos.com(jp)
@dr-cos.com
https://www.facebook.com/drcoscom
https://www.facebook.com/drcoscom

Flap position



Grain Line

Bonding line AC

Seam allowance 1/2in.
Bonding line Da

Bonding line AC
Grain Line

LADIES' size

Military Shirt
Cuffs two sheets
Fusible interlining two sheets

Seam allowance 1/2in.



SITE <http://drcos.info/en> <http://drcos.com/jp>
 MAIL info@drcos.com
 Twitter https://twitter.com/drcos_com
 facebook <https://www.facebook.com/drcoscom>

Bonding line AD

LA

From

Bonding line Aa

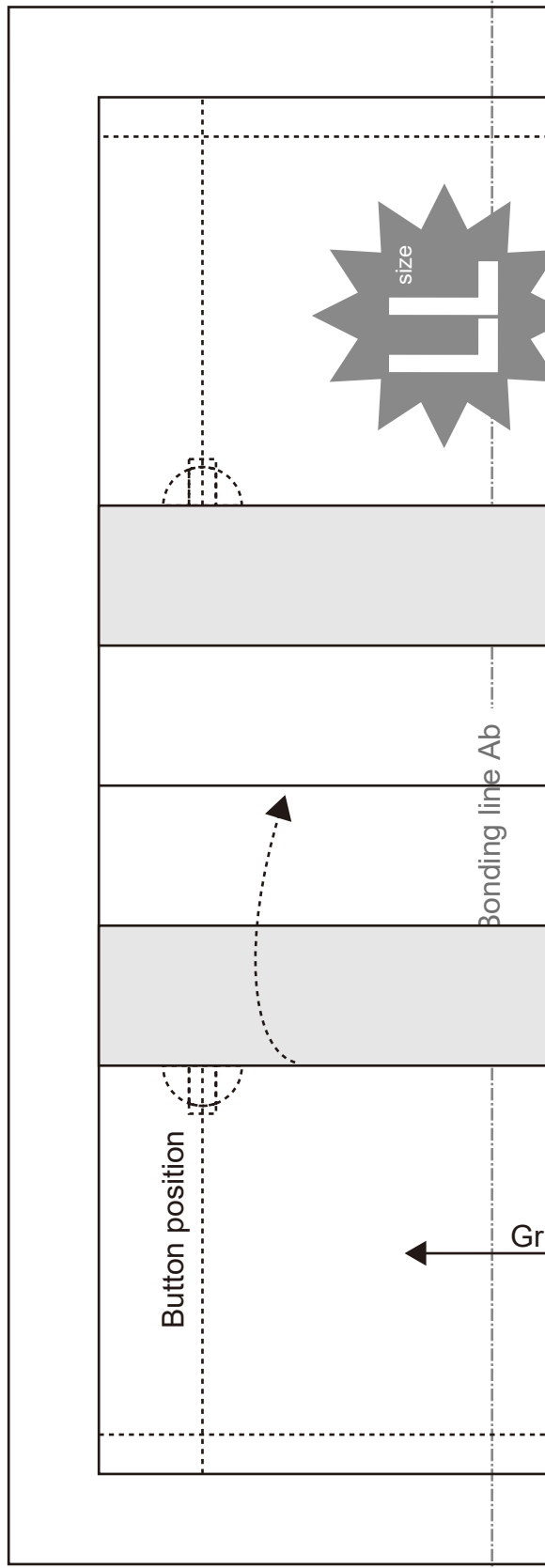
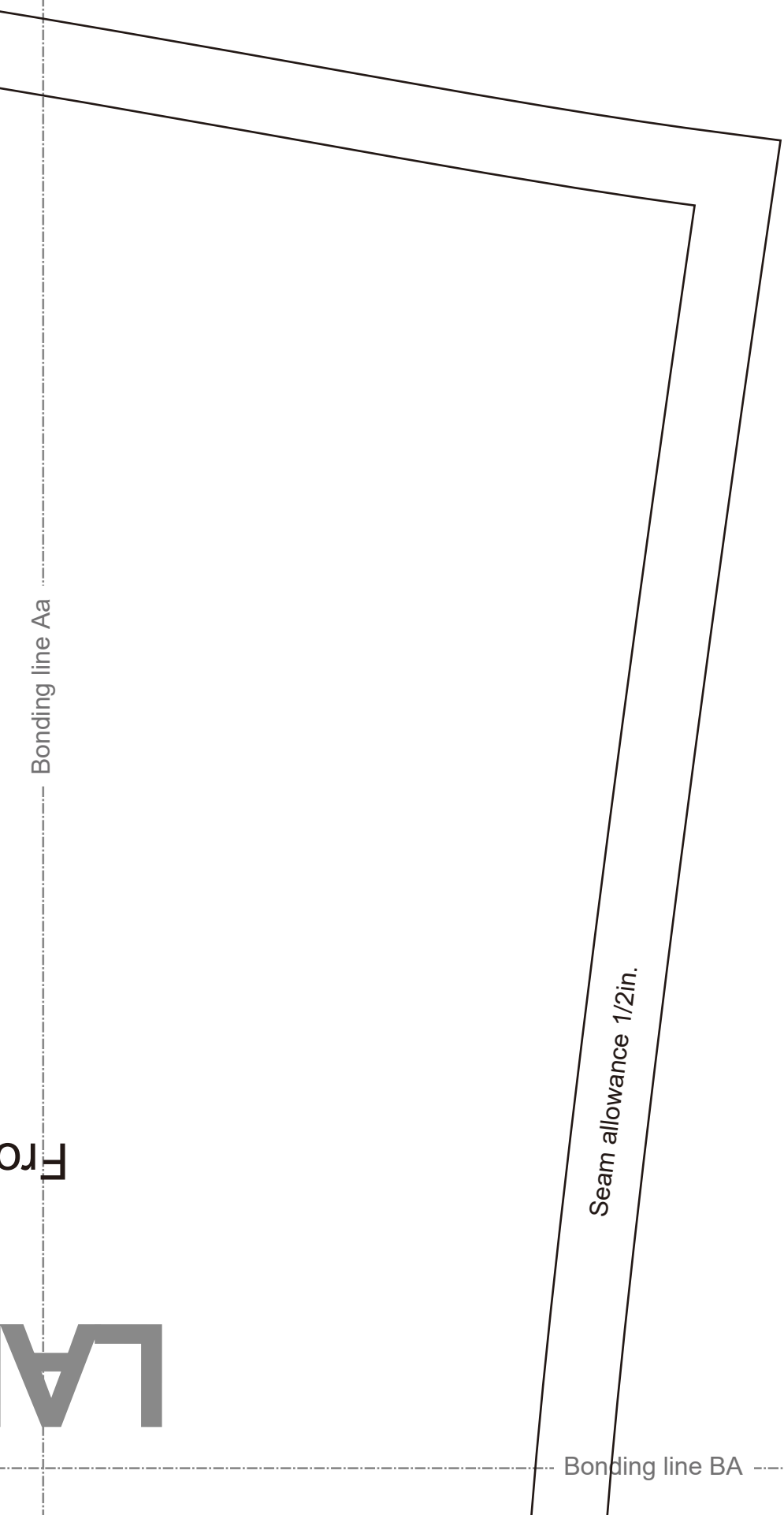

Bonding line BA

DRCOS

SITE [http://dr-cos.info\(en\)](http://dr-cos.info(en)) [http://dr-cos.com\(jp\)](http://dr-cos.com(jp))
MAIL info@dr-cos.com
Twitter https://twitter.com/drcos_com
facebook <https://www.facebook.com/drcoscom>

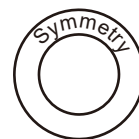

Milit
Back
one

Seam a

Bonding line Bb

Baste

DRCOS

SITE [http://dr-cos.info\(en\)](http://dr-cos.info(en)) [http://dr-cos.com\(jp\)](http://dr-cos.com(jp))
MAIL info@dr-cos.com
Twitter https://twitter.com/drcos_com
facebook <https://www.facebook.com/drcoscom>

Bonding line BB

Bonding line Ba

Bonding line BB

Ca
Bc
DRO
SITE <http://dr-cos.info/en>
MAIL info@dr-cos.com
Twitter <https://twitter.com/dr-cos>
facebook <https://www.facebook.com/dr-cos>

Epaulette po



Bonding line BC

LA
Bonding line Cb



Bonding line BC



collar position

DRCOS
SITE <http://dr-cos.info/en> <http://dr-cos.com>
MAIL info@dr-cos.com
TWITTER <https://twitter.com/@drcos>
FACEBOOK <https://www.facebook.com/drcoscom>



Military Shirt
collar stand
two sheets
Fusible interlining
one sheets

Seam allowance 1/2in.

Bonding line Da

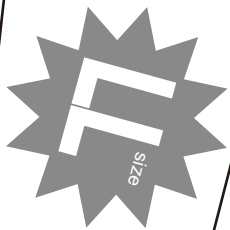

Grain Line

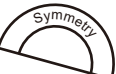

Bonding line BD

Bonding line Db

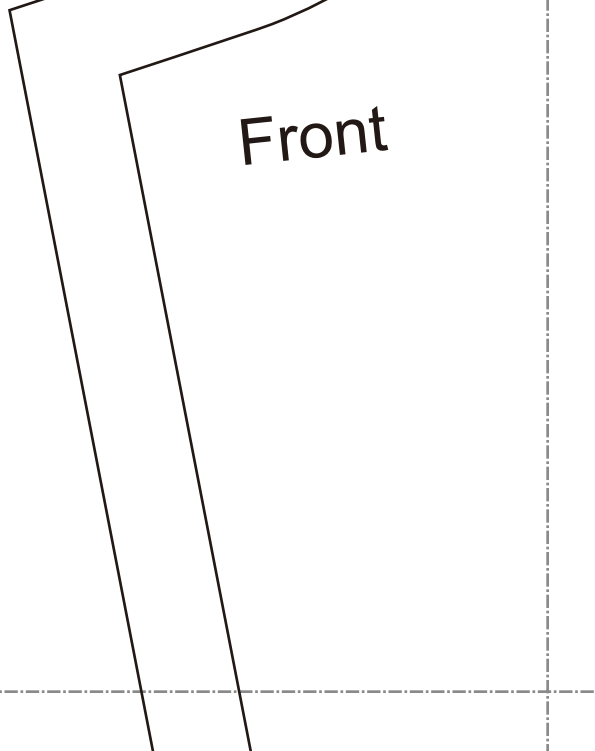
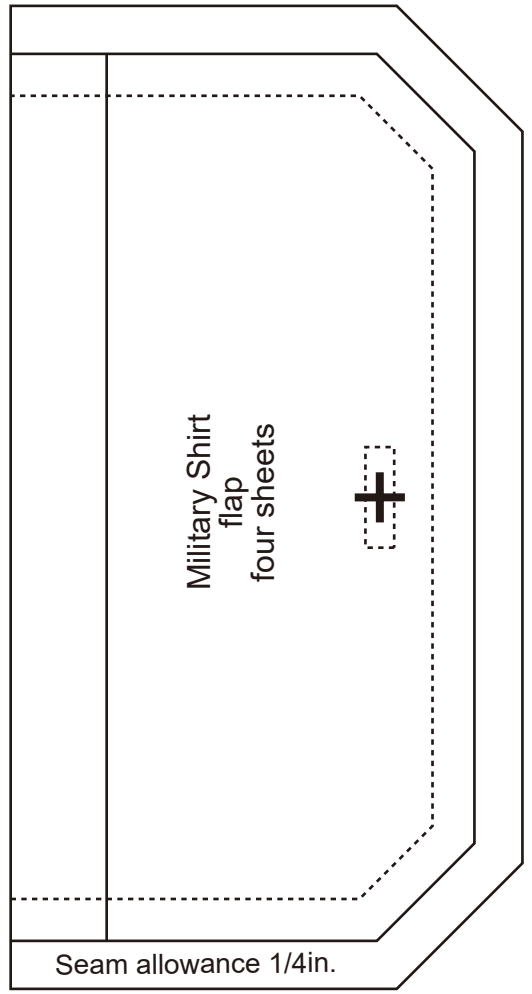
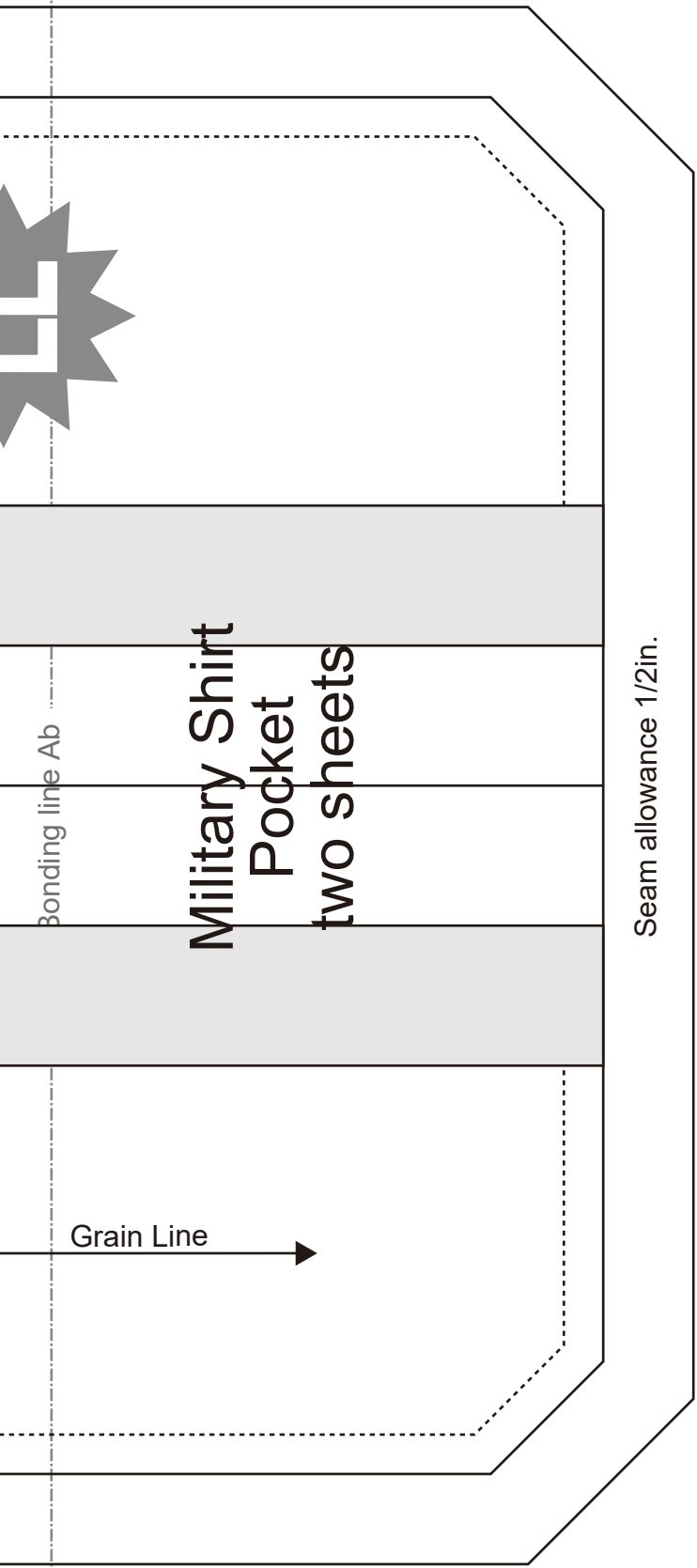

Bonding line CA

Bonding line Ac

Bonding line CA

Epaulette position

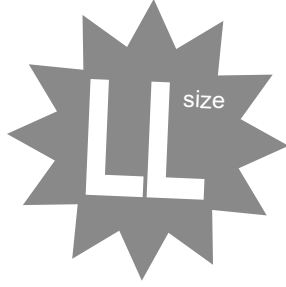

Grain Line



Military Shirt Back Top Body one sheets

Bonding line Bb

Seam allowance 1/2in.

Bonding line Bc

Bonding line CB

Bonding line CB

LADIES' **LL** size

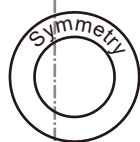

Military Shirt
Back Bottom Body
one sheets

Bonding line Cc

Bonding line CC

Bonding line CC



Bonding line Db

Bonding line Dc

Seam allowance 1/2in.

Bonding line CD

DRCOS

SITE [http://dr-cos.info\(en\)](http://dr-cos.info(en)) [http://dr-cos.com\(jp\)](http://dr-cos.com(jp))

MAIL info@dr-cos.com

Twitter https://twitter.com/@drcos_com

facebook <https://www.facebook.com/drcoscom>

Bonding line Ad

Bonding line Ad

Bonding line DA

LADIES'  size

Bonding line DA

LADIES' size

Military Shirt
Sleeve
two sheets

Bonding line Bc

Bonding line Bd



Bonding line DB

Bonding line DB

Bonding line Cc

Bonding line Cd

Seam allowance 1/2in.

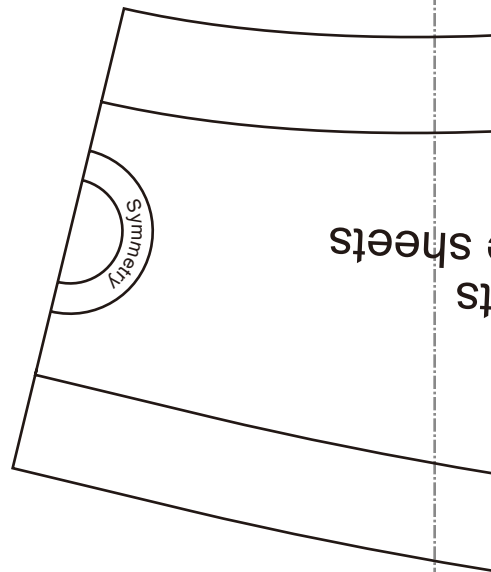
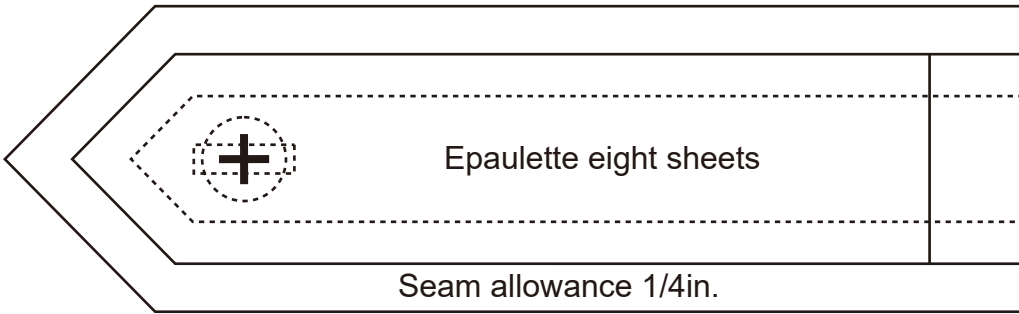
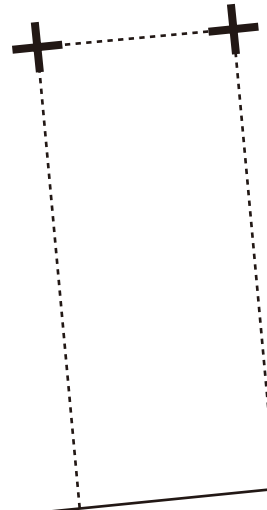

Bonding line DC

Bonding line Ad

Back

Bonding line EA

Military Shirt
Facing two sheets
Fusible interlining two sheets

Grain Line

Bonding line Ae

Bonding line Bd

Bonding line EA



Bonding line EB

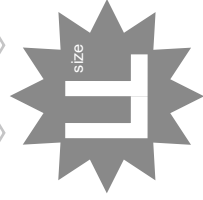

Seam allowance 1/2in.

Bonding line Be

Bonding line EB

Bonding line Cd

Bonding line Ce

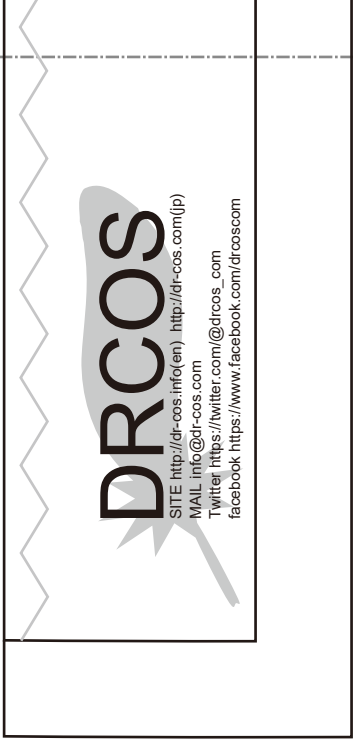

Military Shirt
 Collar two sheets
 Fusible interlining one sheet



Grain Line

Seam allowance 1/2in.



Bonding line EC