

Seam allowance 1/2in.

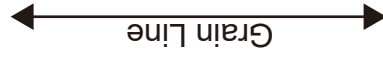

Bonding line Aa

Bonding line AA

Bonding line AA

Bonding line Ba

Seam allowance 1/2in.

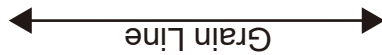

Bonding line AB

Bonding line AB

Bonding line Ca

Seam allowance 1/2in.

Pocket position

**Military Jacket
Front Bottom Body
Two sheets**

Bonding line AC

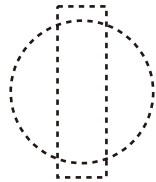

Bonding line AC



Open fastener position

DRCOS

SITE [http://dr-cos.info\(en\)](http://dr-cos.info(en)) [http://dr-cos.com\(jp\)](http://dr-cos.com(jp))
MAIL info@dr-cos.com
Twitter https://twitter.com/@drcos_com
facebook <https://www.facebook.com/drcoscom>

LADIES

Bonding line Da

DRCOS

SITE [http://dr-cos.info\(en\)](http://dr-cos.info(en)) [http://dr-cos.com\(jp\)](http://dr-cos.com(jp))
MAIL info@dr-cos.com
Twitter https://twitter.com/@drcos_com
facebook <https://www.facebook.com/drcoscom>

LADIES

Bonding line AD

Bonding line Aa

Bonding line Ab

LADIES'S
size
S

Military Jacket
Back Bottom Body
Two sheets

Bonding line BA

Bonding line BA

Bonding line Ba

Bonding line Bb

LADIES'S
size

**Military Jacket
Sleeve
two sheets**

Bonding line BB

Bonding line BB

Bonding line Ca

Bonding line Cb

DRCOS
 SITE <http://dr-cos.info/en> <http://dr-cos.com/tp>
 MAIL info@dr-cos.com
 Twitter <https://twitter.com/dr-cos>
 facebook <https://www.facebook.com/drcoscom>

LADIES'S
 size
S

Baste



Bonding line BC

Pocket position



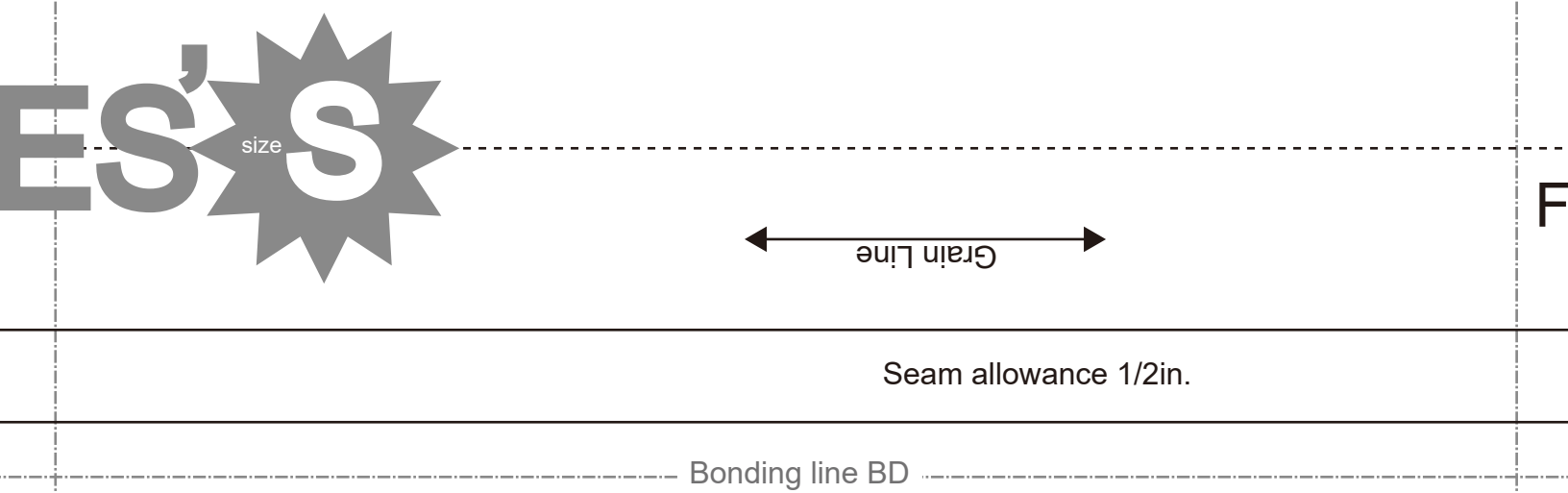
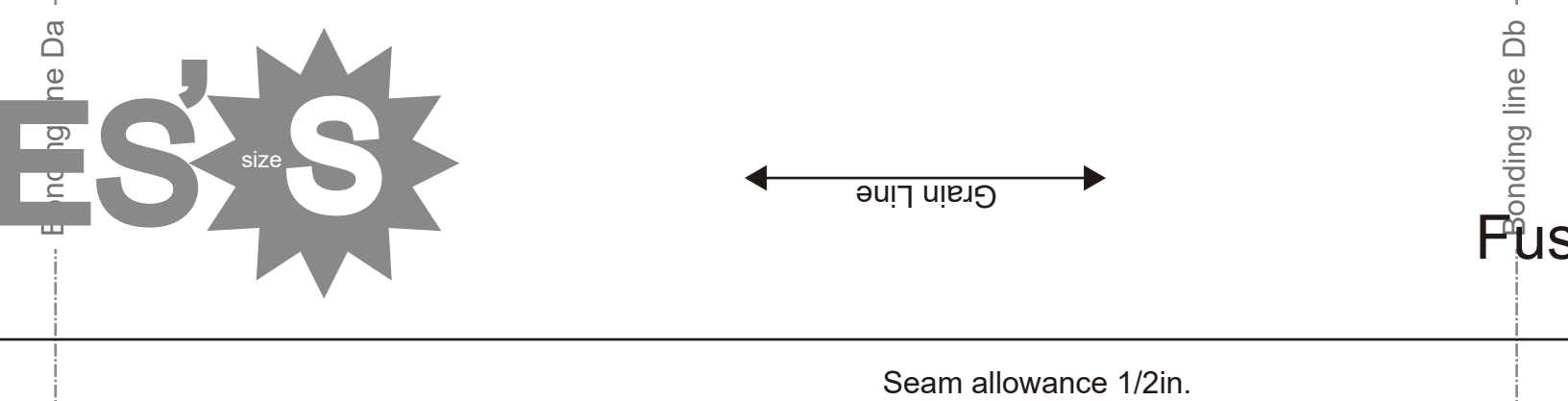
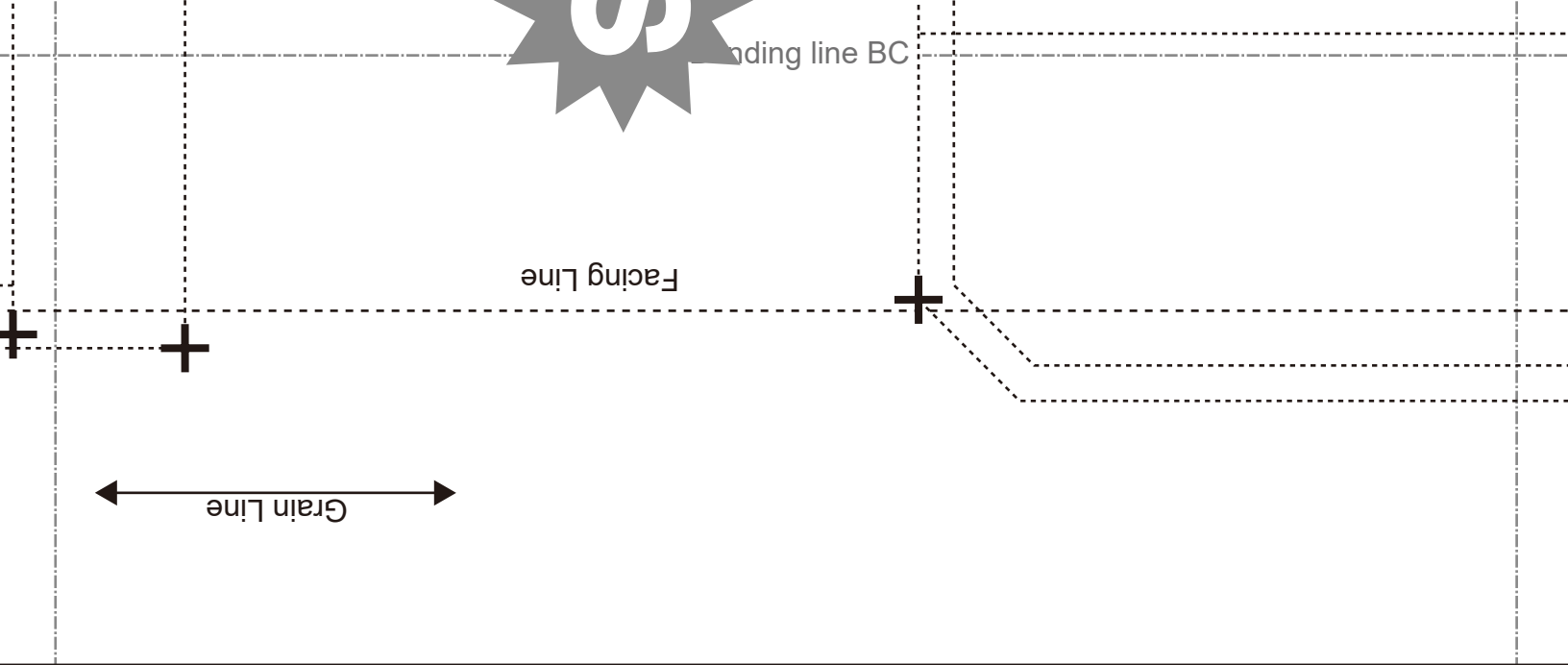



LADIES'S



Military Jacket
Back Top Body
one sheets

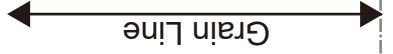

Seam allowance 1/2in.

DRCOS

SITE <http://dr-cos.info/en>) [http://dr-cos.com\(lp\)](http://dr-cos.com(lp))
MAIL info@dr-cos.com
Twitter [@drcos_com](https://twitter.com/@drcos_com)
facebook <https://www.facebook.com/drcos.com>

Bonding line Ab

Bonding line CA

LADIES'S

LADIES'S size

LADIES'S

Bonding line CA

Front

Military Jacket
flap
two sheets

Seam allowance 1/2in.

Bonding line Bb

Bonding line Bc

SITE <http://dr-cos.info/en> <http://dr-cos.com/jp>
MAIL info@dr-cos.com
Twitter <https://twitter.com/dr-cos>
facebook <https://www.facebook.com/dr-cos.com>

DR-COS

Bonding line CB

Bonding line CB

Back

Military Jacket
flap
four sheets

Bonding line Cc

Bonding line Cb

DRCOS
SITE <http://dr-cos.info/en> <http://dr-cos.com/jp>
MAIL info@dr-cos.com
T.witter <https://twitter.com/@drcos> <https://www.facebook.com/drcoscom>

Epaule

LADIES'S
size

Military Jacket
Front Top Body
Two sheets

Bonding line Cc

Flap position

Pocket position



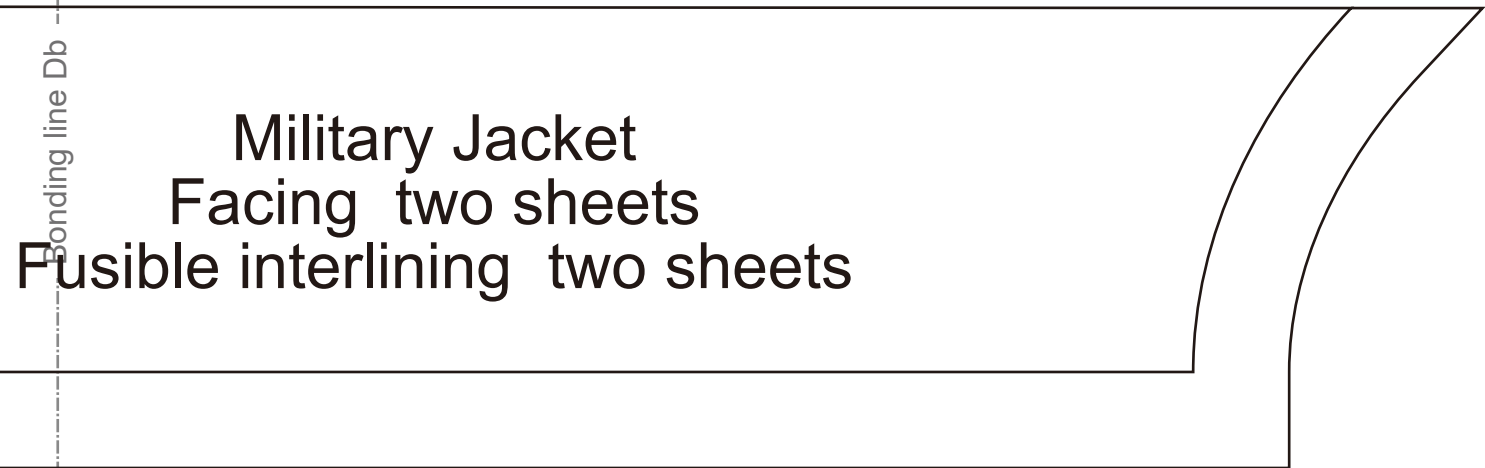
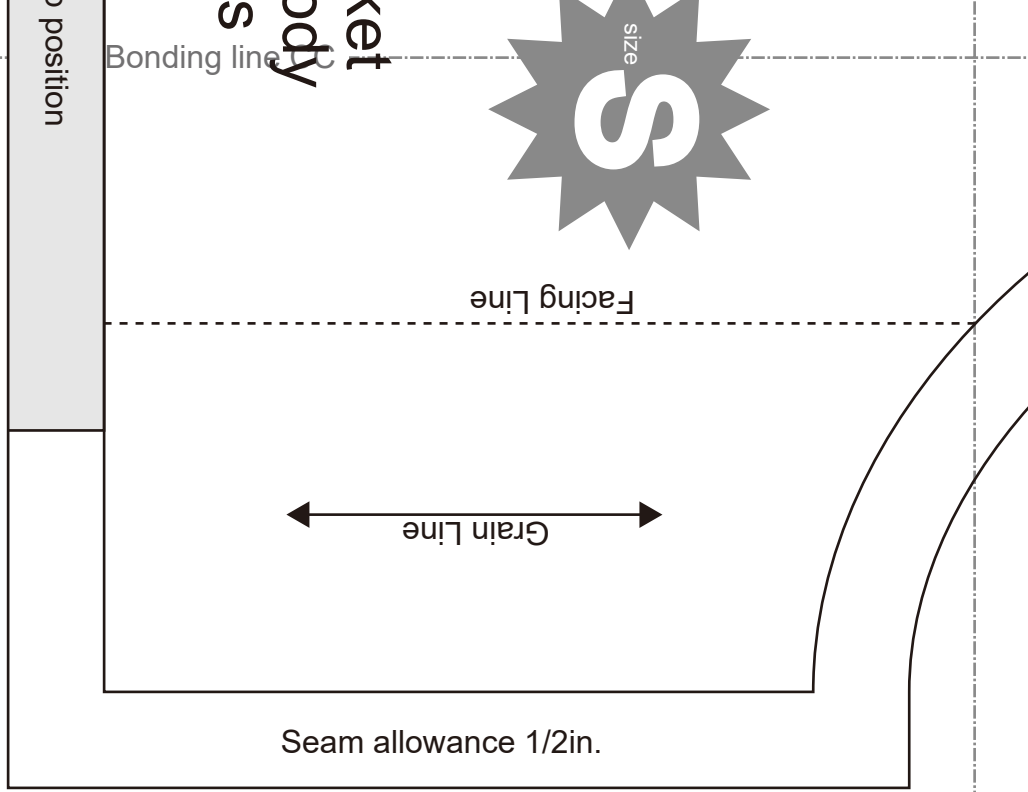
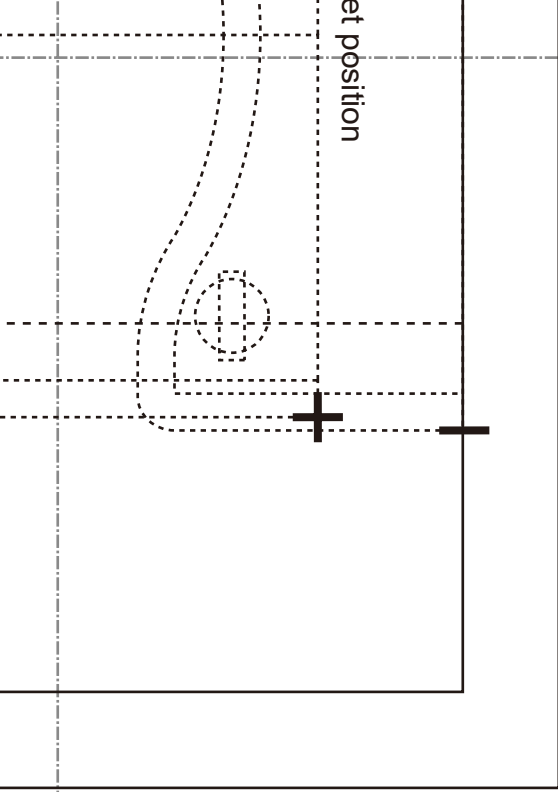

Military Jacket
Facing two sheets
Fusible interlining two sheets

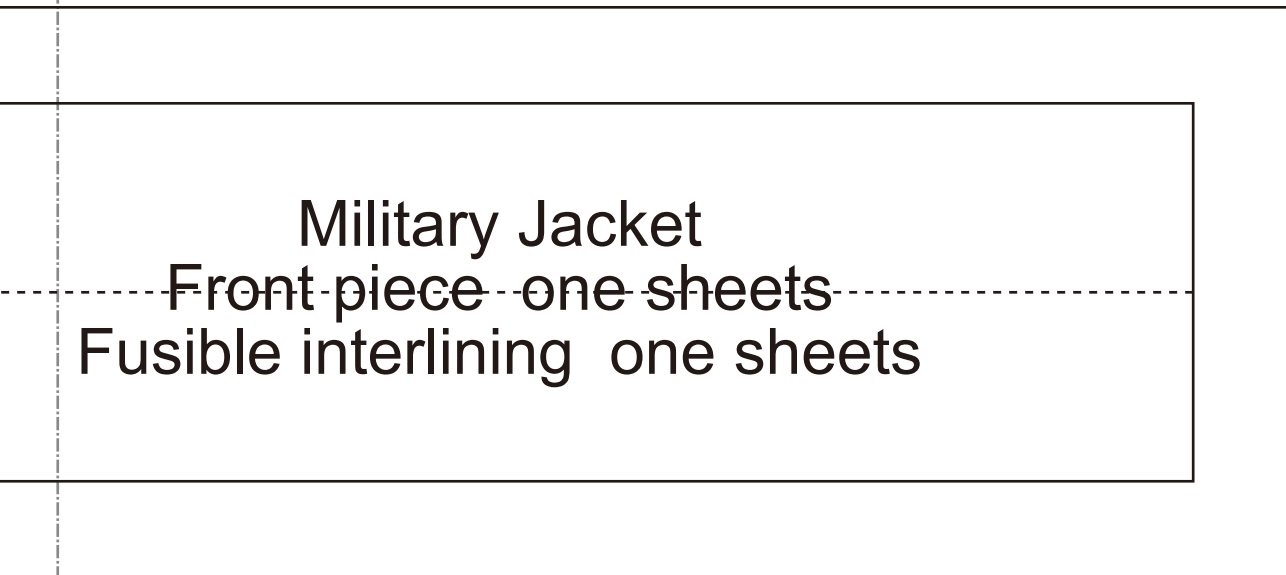

Military Jacket
Front piece one sheets
Fusible interlining one sheets

Bonding line CD

Military Jacket

Collar two sheets

Fusible interlining one sheets

Seam allowance 1/2in.

Front piece

Grain Line

Epaulette position

Bonding line DA

DRCOS

SITE [http://dr-cos.info\(en\)](http://dr-cos.info/en) <http://dr-cos.com/tp>
MAIL info@dr-cos.com
Twitter <https://twitter.com/dr-cos>
facebook <https://www.facebook.com/drcoscom>

ADIES

ES'S

size

ES'S
size S

y Jacket
ap
neets

ce 1/2in.

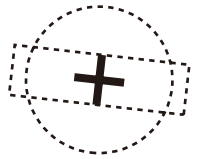

Bonding line DA

LADIES'S
size S

DRCOS
SITE <http://dr-cos.info/en/> <http://dr-cos.com/lp/>
MAIL info@dr-cos.com
Twitter [@drcos_com](https://twitter.com/@drcos_com)
facebook <https://www.facebook.com/drcos.com>

Bonding line Bd

Bonding line Bc

DRCOS
SITE <http://dr-cos.info/en/> <http://dr-cos.com/lp/>
MAIL info@dr-cos.com
Twitter [@drcos_com](https://twitter.com/@drcos_com)

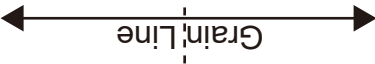

Bonding line DB

Bonding line DB

LADIES'S

size

Bonding line Cd

Military Jacket Cuffs two sheets Fusible interlining two sheets

Seam allowance 1/2in.



SITE <http://dr-cos.info/en> <http://dr-cos.com/jp>
MAIL info@dr-cos.com
Twitter [@drcos_com](https://twitter.com/@drcos_com)
facebook <https://www.facebook.com/drcos.com>

Bonding line DC

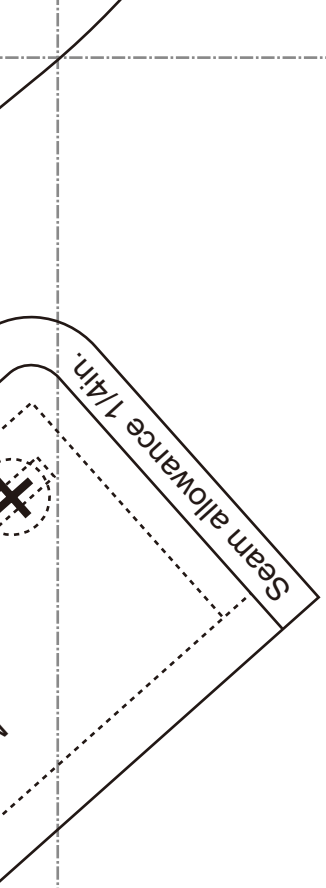

Seam allowance 1/4in.

Bonding line Cc

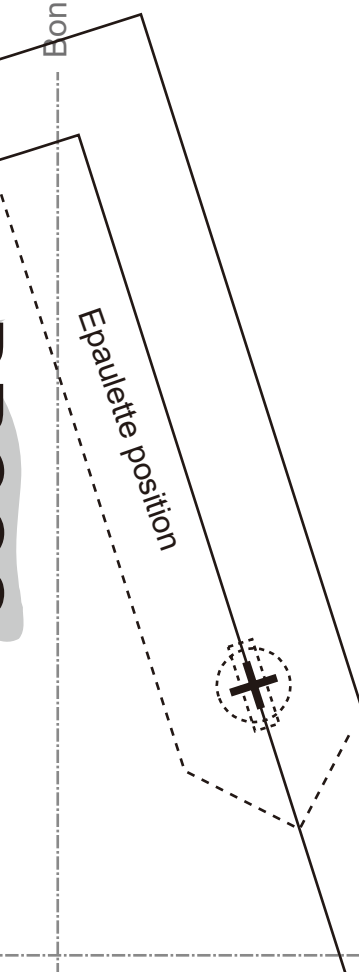

Epaulette position

Bonding line DC

Bonding line Dc

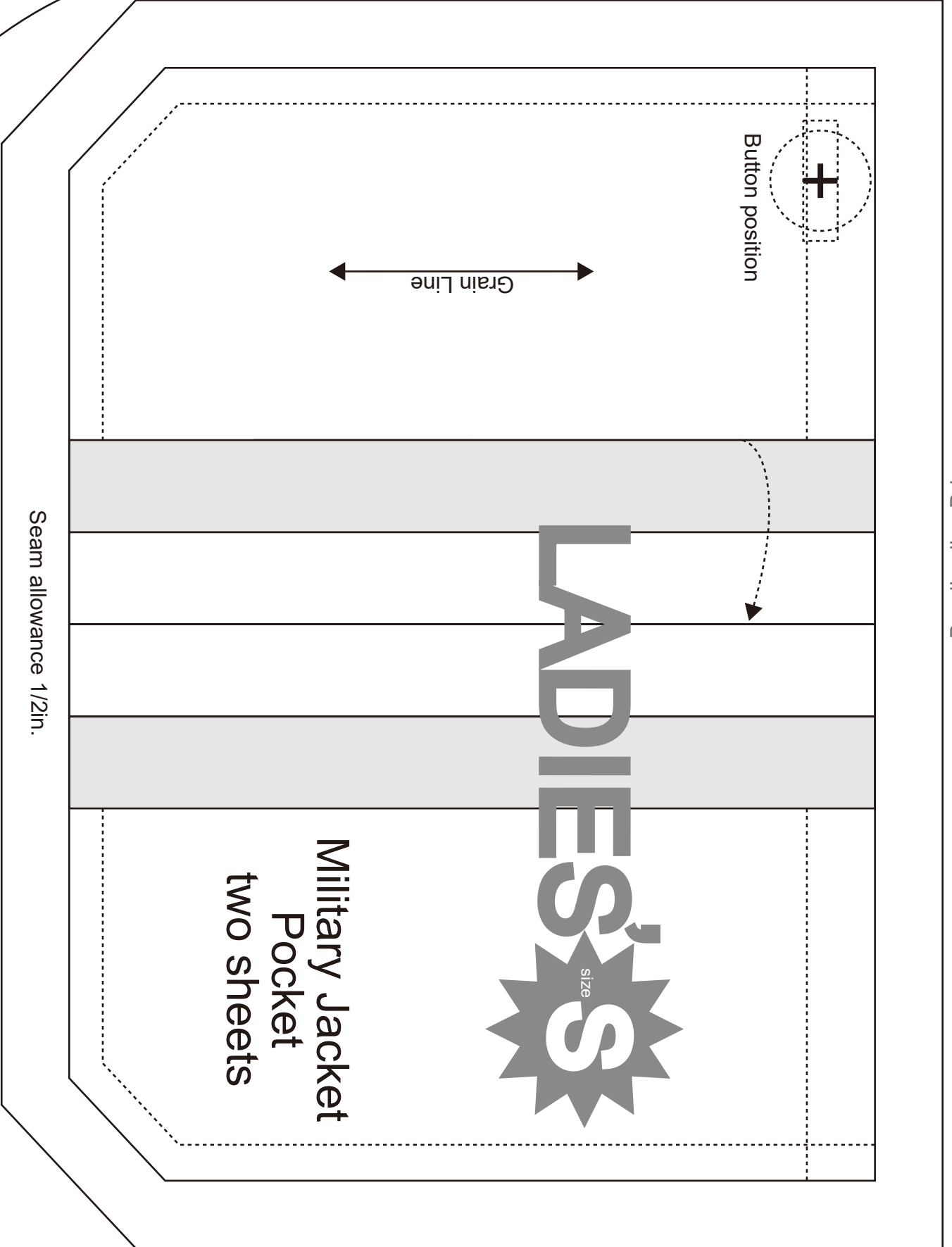

Seam allowance 1/2in.

Grain Line

Button position

Bonding line DD

Bonding line Dd

