

Bonding line AA

two sheets.

Spread it out, **Bend on the dotted line to create, two sheets.**

Bonding line AA



Bonding line AA

Seam allowance 1/2in.

Bonding line Ba

Bonding line AB

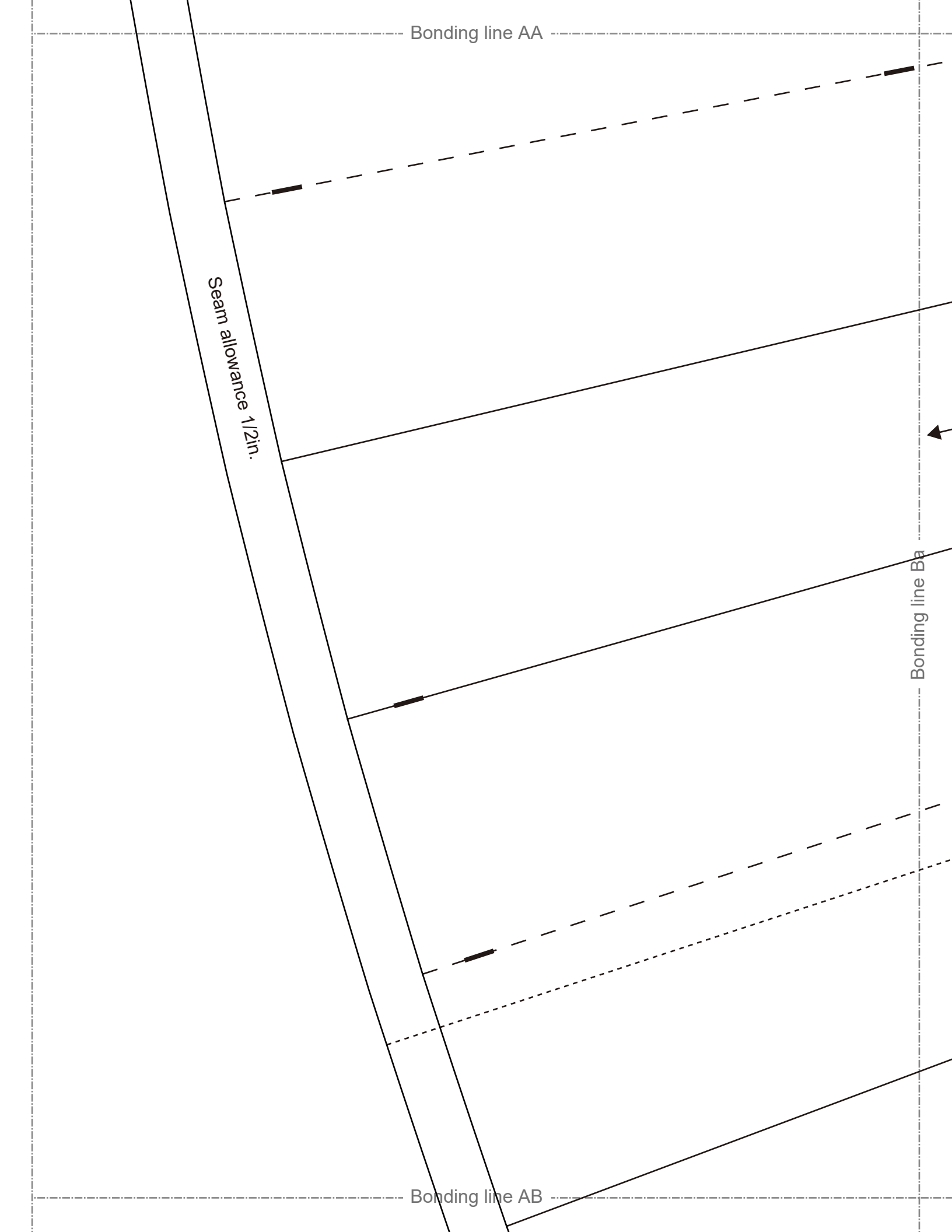

Bonding line AB

Seam allowance 1/2in.



Hakama (Mebakama)
koshiita two sheets
Fusible interlining one sheets
match marks



Bonding line Ca

Bonding line AC

spread it out, two sheets.
create, two sheets.

Children's 8

Hakama (Mebakama)

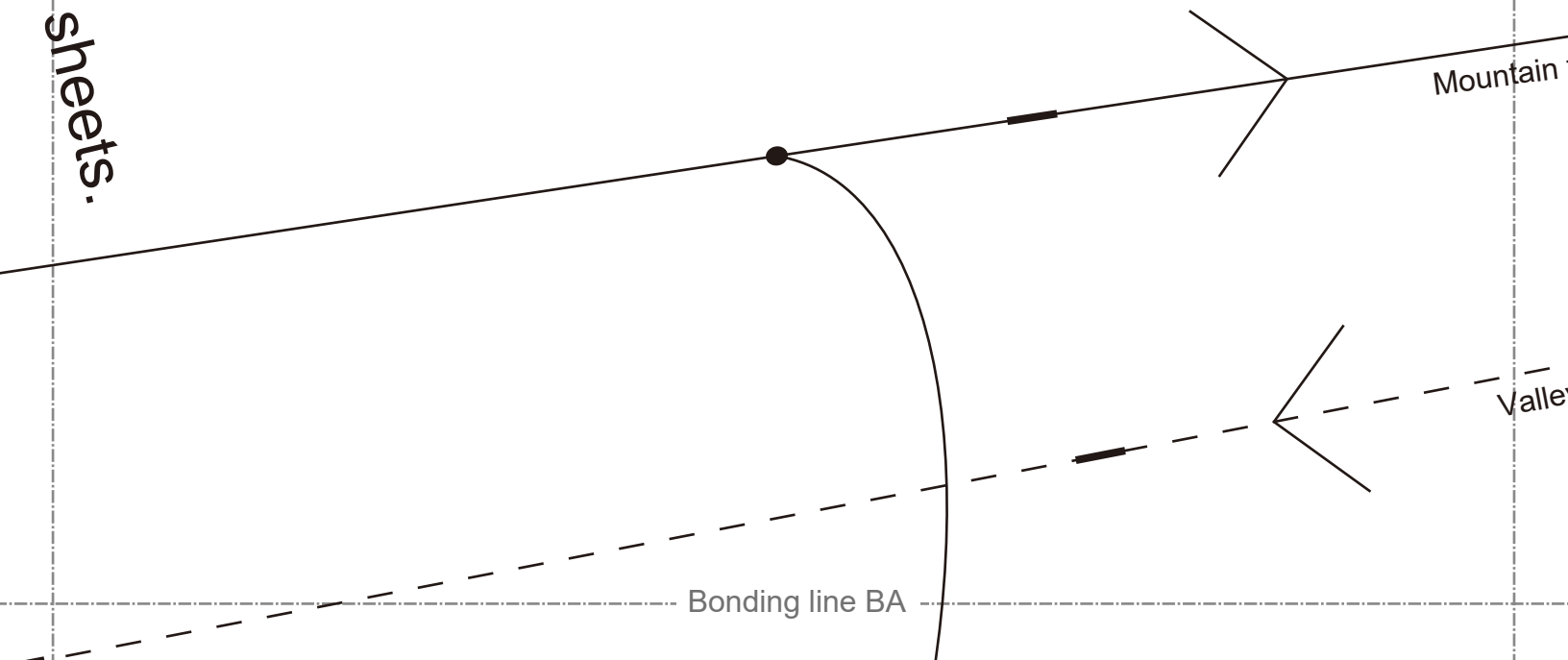

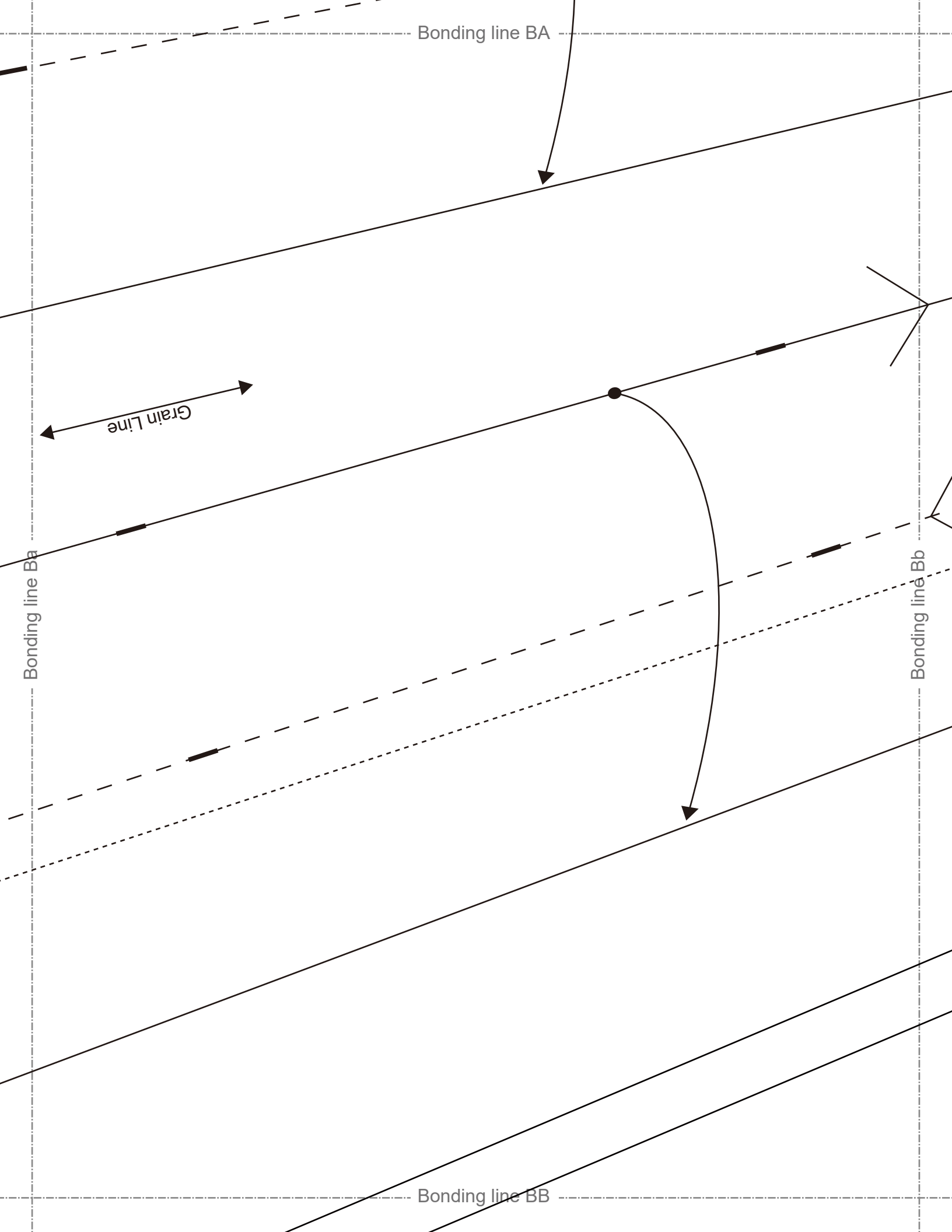

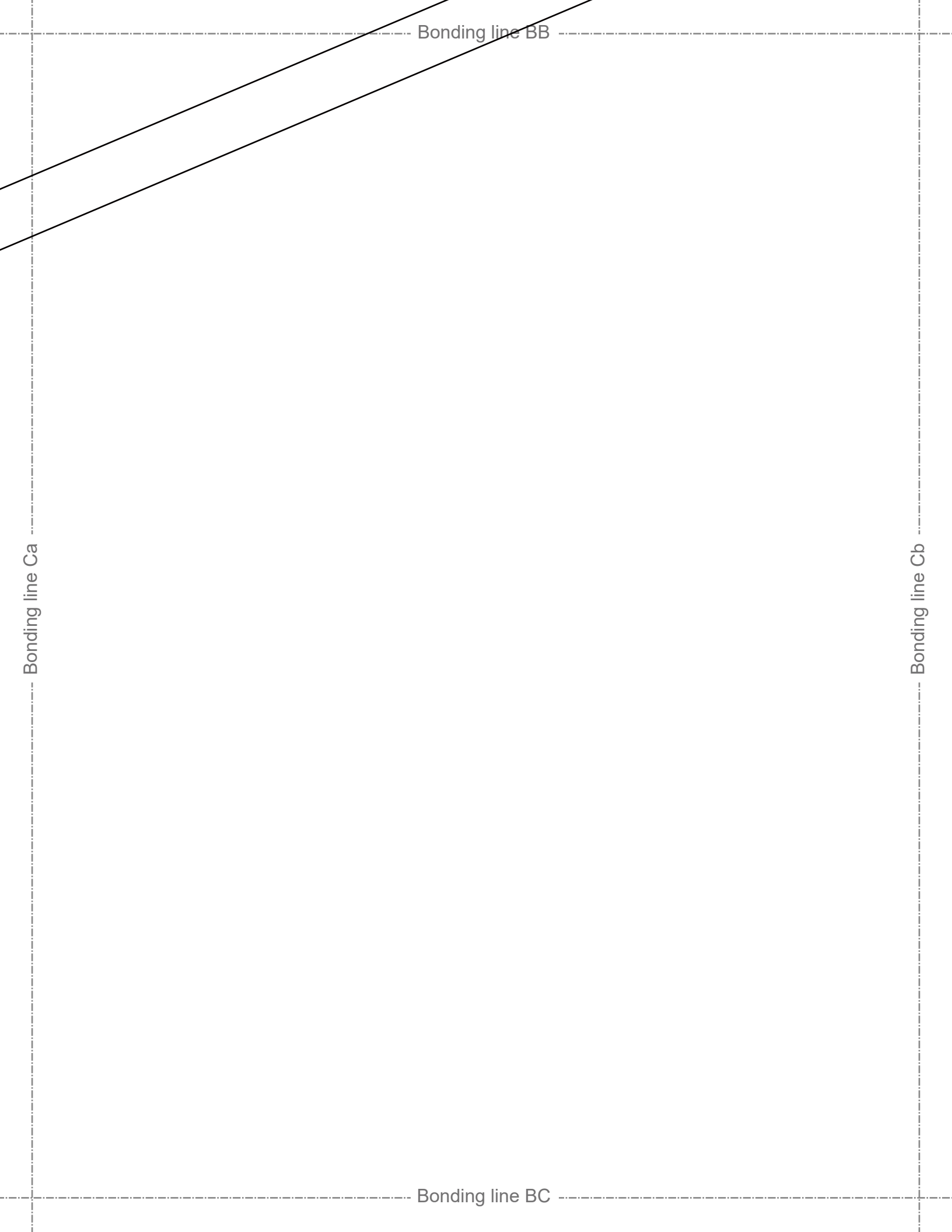

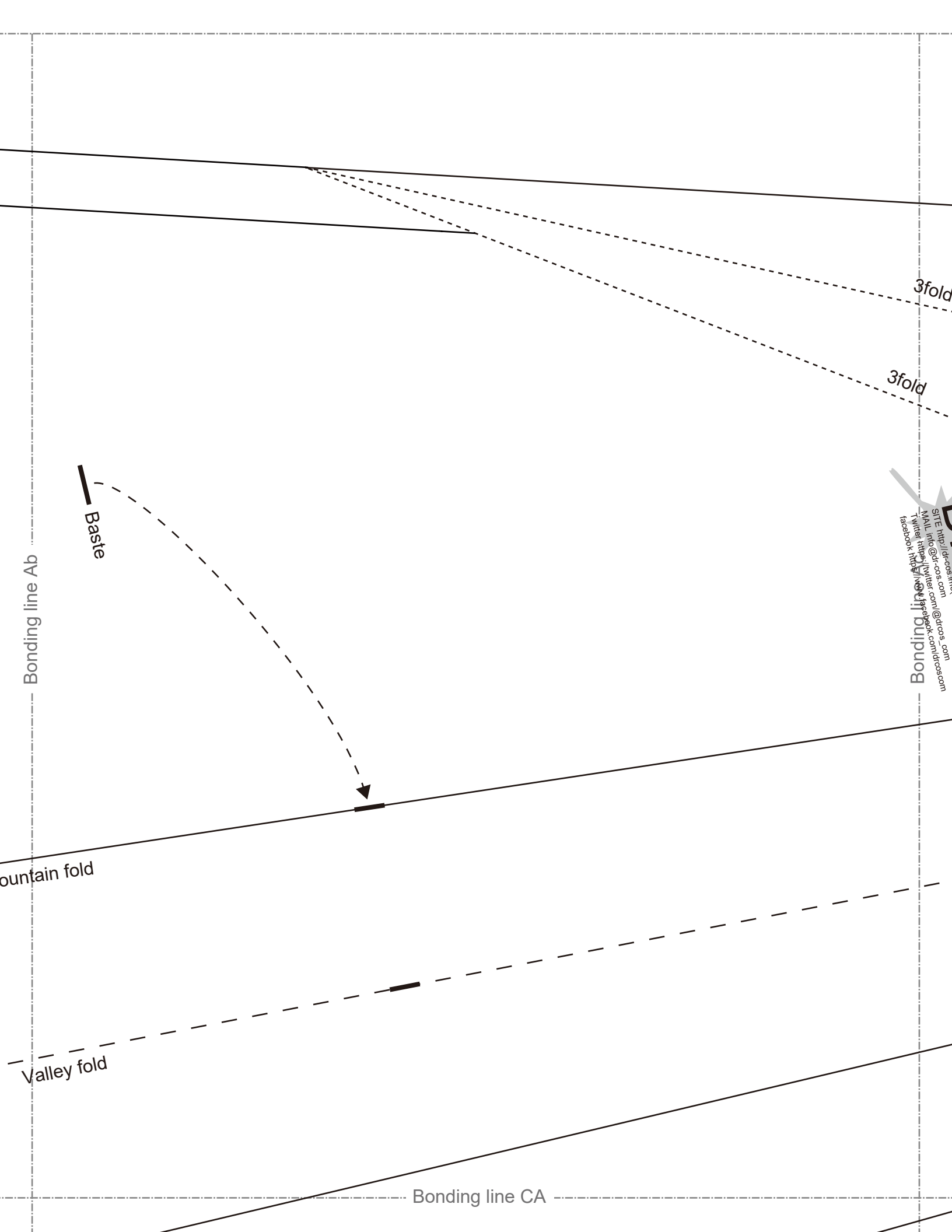

Bonding line Ab

Baste

3fold

3fold

SITE <http://dr-cos.com>
MAIL info@dr-cos.com
Twitter <https://twitter.com/dr-cos>
Facebook <https://www.facebook.com/dr-cos.com>

Bonding line Ab

Mountain fold

Valley fold

Bonding line CA

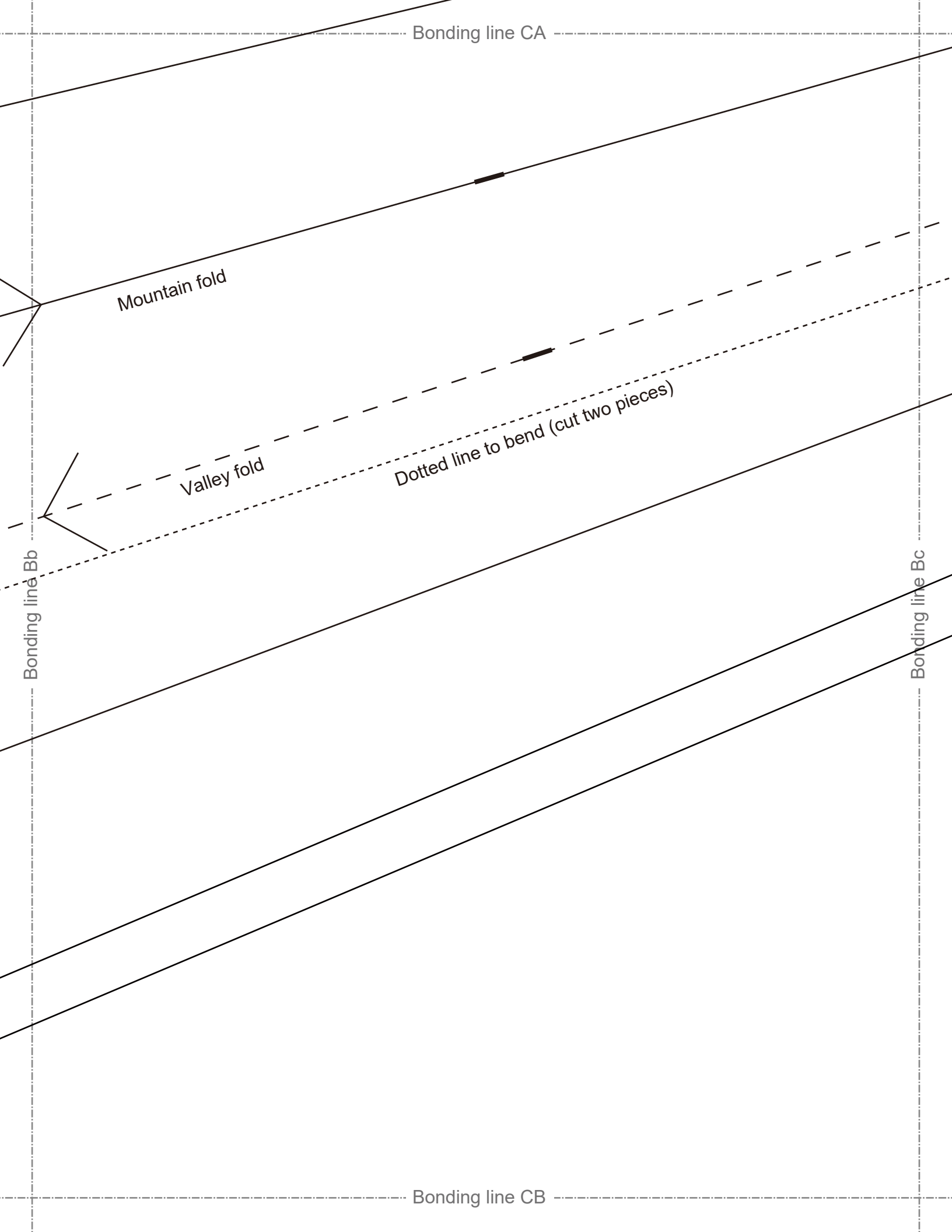

Bonding line CA

Mountain fold

Valley fold

Dotted line to bend (cut two pieces)

Bonding line Bb

Bonding line Bc

Bonding line CB

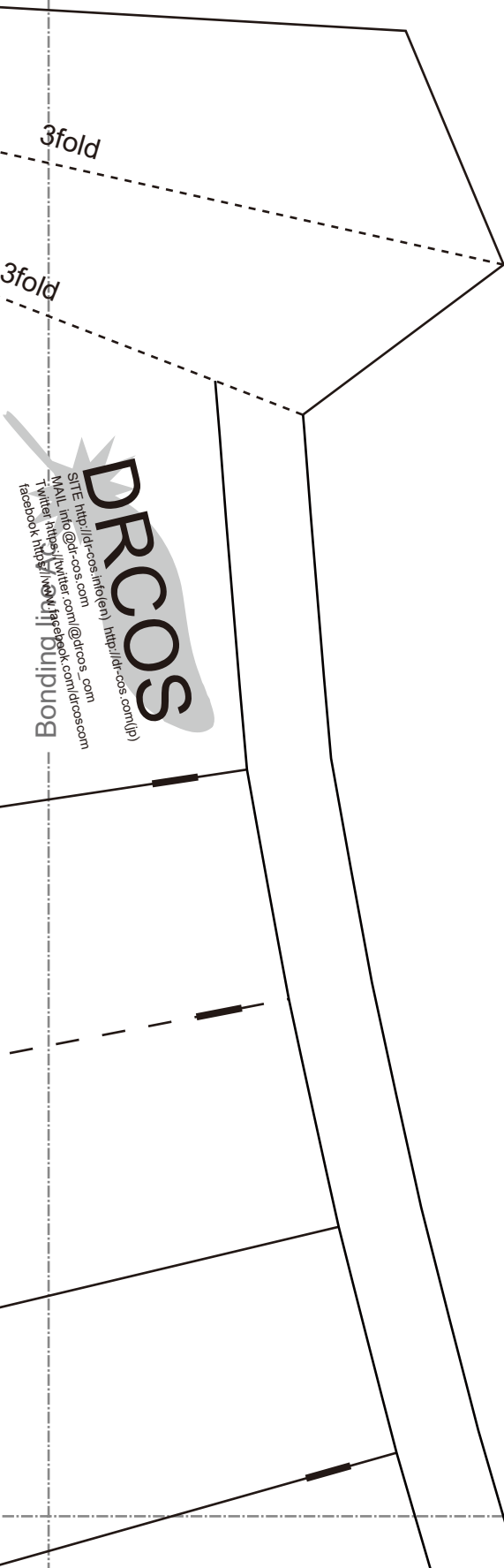

3fold

3fold

DRCOS
SITE <http://dr-cos.info/en> <http://dr-cos.com/jp>
MAIL info@dr-cos.com
Twitter <https://twitter.com/dr-cos> www.facebook.com/drcos.com
facebook <https://www.facebook.com/drcos.com>

Bonding line Ad

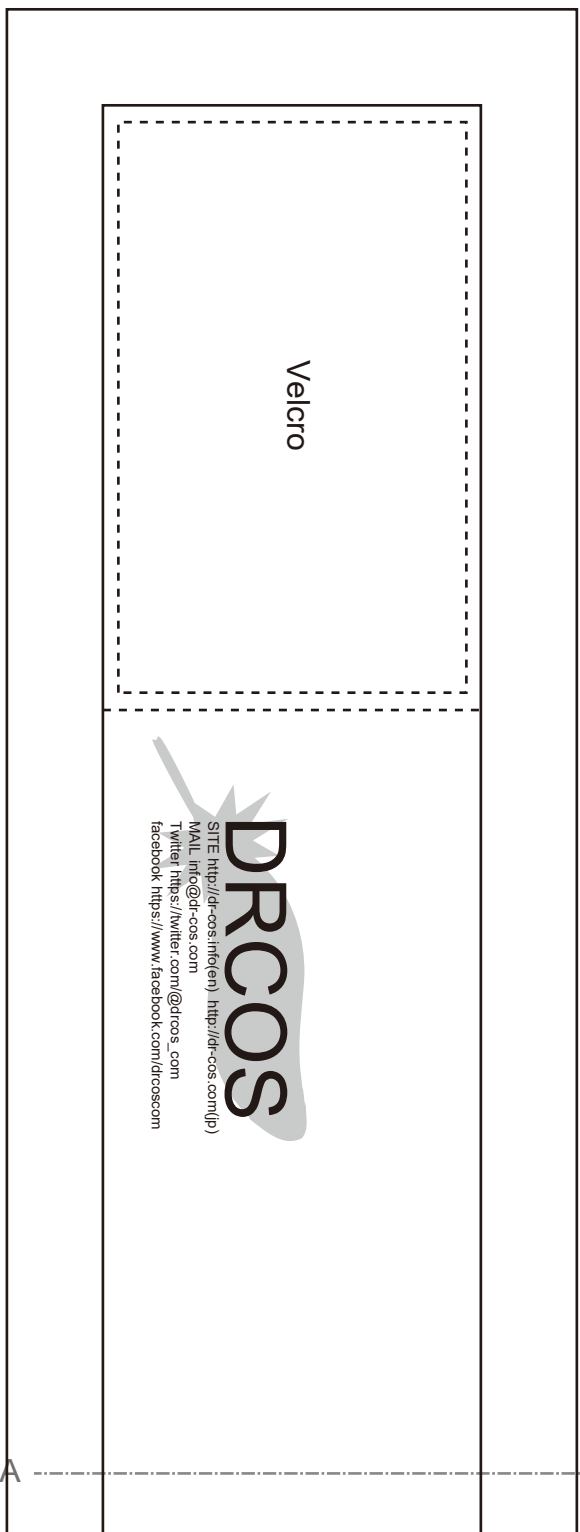

Velcro

DRCOS
SITE <http://dr-cos.info/en> <http://dr-cos.com/jp>
MAIL info@dr-cos.com
Twitter <https://twitter.com/dr-cos> www.facebook.com/drcos.com
facebook <https://www.facebook.com/drcos.com>

Bonding line Ad

Bonding line Ad

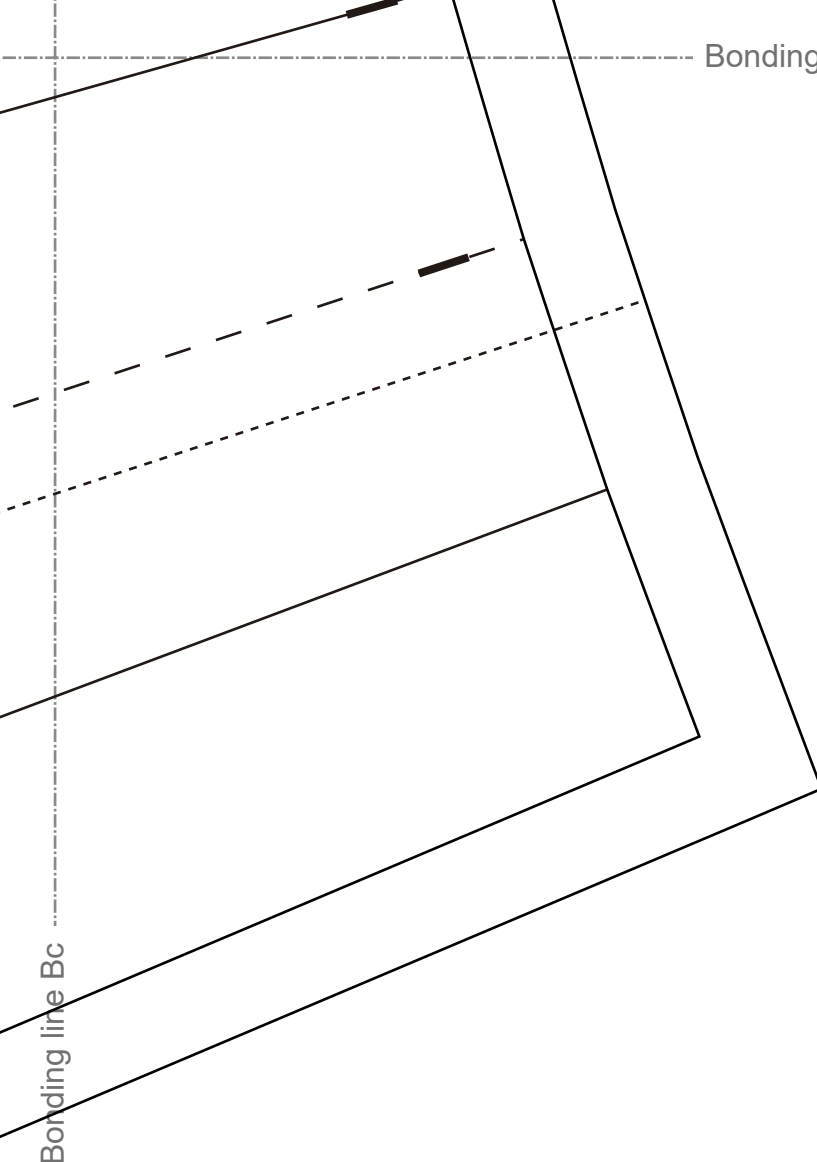

match marks

Children's  **8**
size

Seam allowance 1/2in.

Hakama(Mebakama)
waistband two sheets
Fusible interlining one sheet

Bonding line Bd

Bonding line DB

ma)
eets.
e sheets

match marks



Grain Line

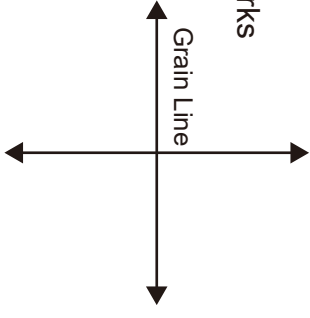

Velcro

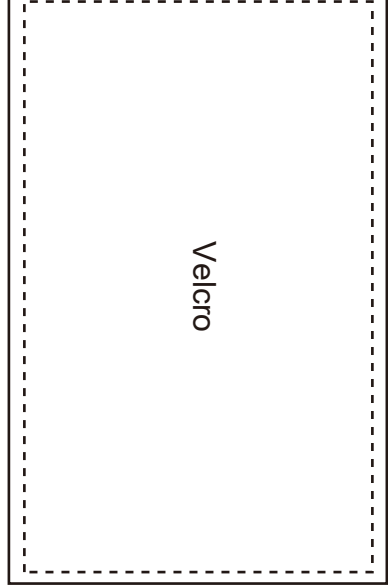

Bonding line Cd

Bonding line DC

Bonding line Cc