

[Home](#)
[Back to Meid2 page](#)

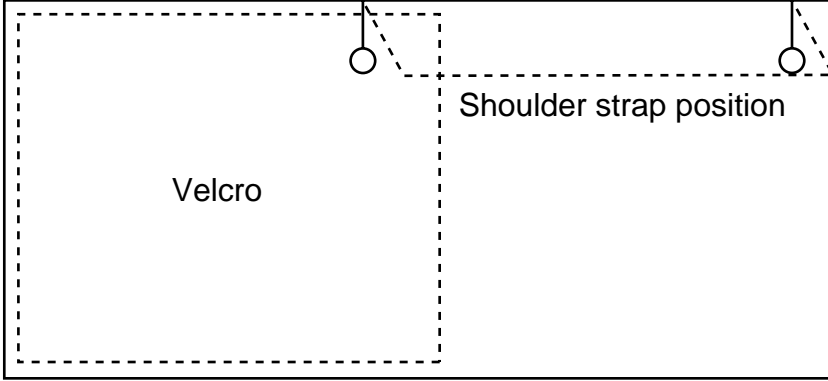

← Grain L

Bonding line Aa

Bonding line AA

Bonding line AA



Bonding line Ba

Bonding line AB

Bonding line AB

Bonding line Ca

Bonding line AC

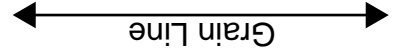

Bonding line AC

Bonding line Da

Bonding line AD

Seam allowance 1/2in.

Seam allowance 1/2in.

Back

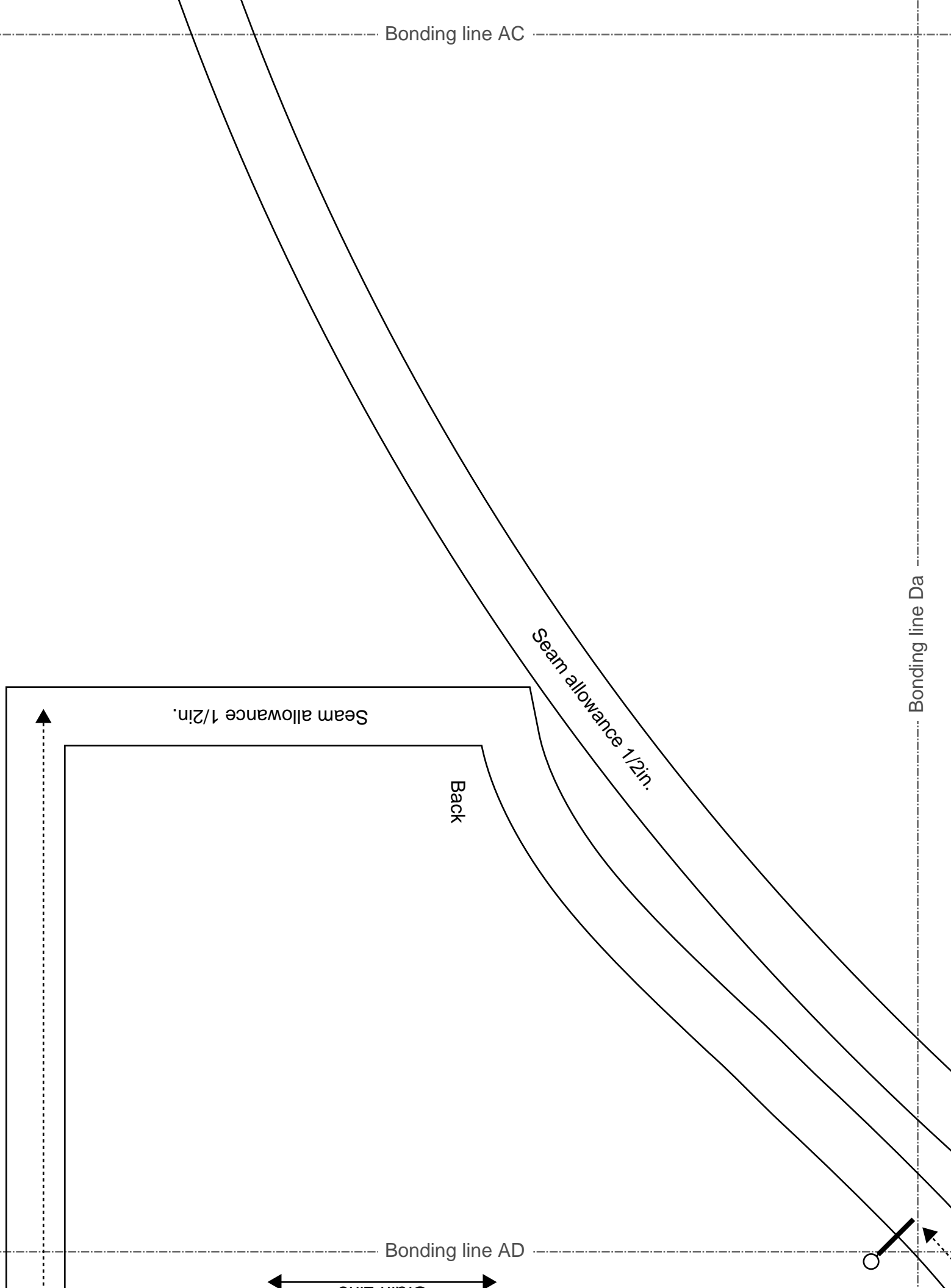

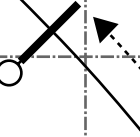

Bonding line Ea



Bonding line AD

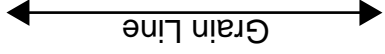

Grain Line

MEN'S size S

Meid2
Sleeve
two sheets

gather

Bonding line AE

Bonding line AE



Front

Bonding line Fa

Meid2
Ribbon core one sheets
Fusible interlining one sheets

Velcro

Velcro

Grain Line

MEN'S size **S** **DRCOS**

SITE [http://dr-cos.info\(en\)](http://dr-cos.info(en)) [http://dr-cos.com\(jp\)](http://dr-cos.com(jp))
MAIL info@dr-cos.com
Twitter [@drcos_com](https://twitter.com/@drcos_com)
facebook <https://www.facebook.com/drcoscom>

Gathered frill race

Bonding line AF

Grain Line →

Meid2
Apron belt two sheets
Fusible interlining one sheets

Bonding line Aa

Bonding line Ab

MEN'S  size S

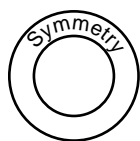

Meid2
Ribbon top parts
one sheets
Fusible interlining
one sheets

Bonding line BA

Bonding line BA

Bonding line Ba

Bonding line Bb

Grain Line

Bonding line BB

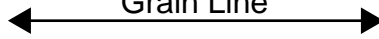

Bonding line BB

Gathered frill race



Bonding line Ca

Bonding line Cb

Bonding line BC



ME

WOMEN'S size S

Meid2
back skirt
one sheets



Bonding line BC

Bonding line BD

Bonding line Da

Bonding line Db

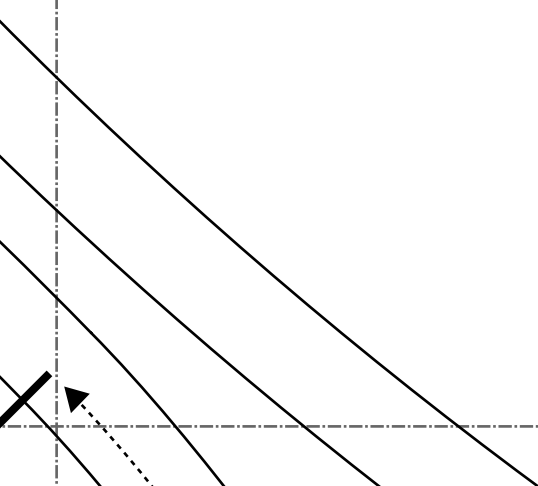

Bonding line BD

Bonding line Ea

Bonding line Eb

gather

Grain Line

MEN'S size **S**

Seam allowance 1/2"

DRCOS

SITE <http://dr-cos.info/en> <http://dr-cos.com/jp>
 MAIL info@dr-cos.com
 Twitter [@drcos.com](https://twitter.com/@drcos.com)
 facebook <https://www.facebook.com/drcos.com>

Bonding line BE

Bonding line BE

Bonding line Fa

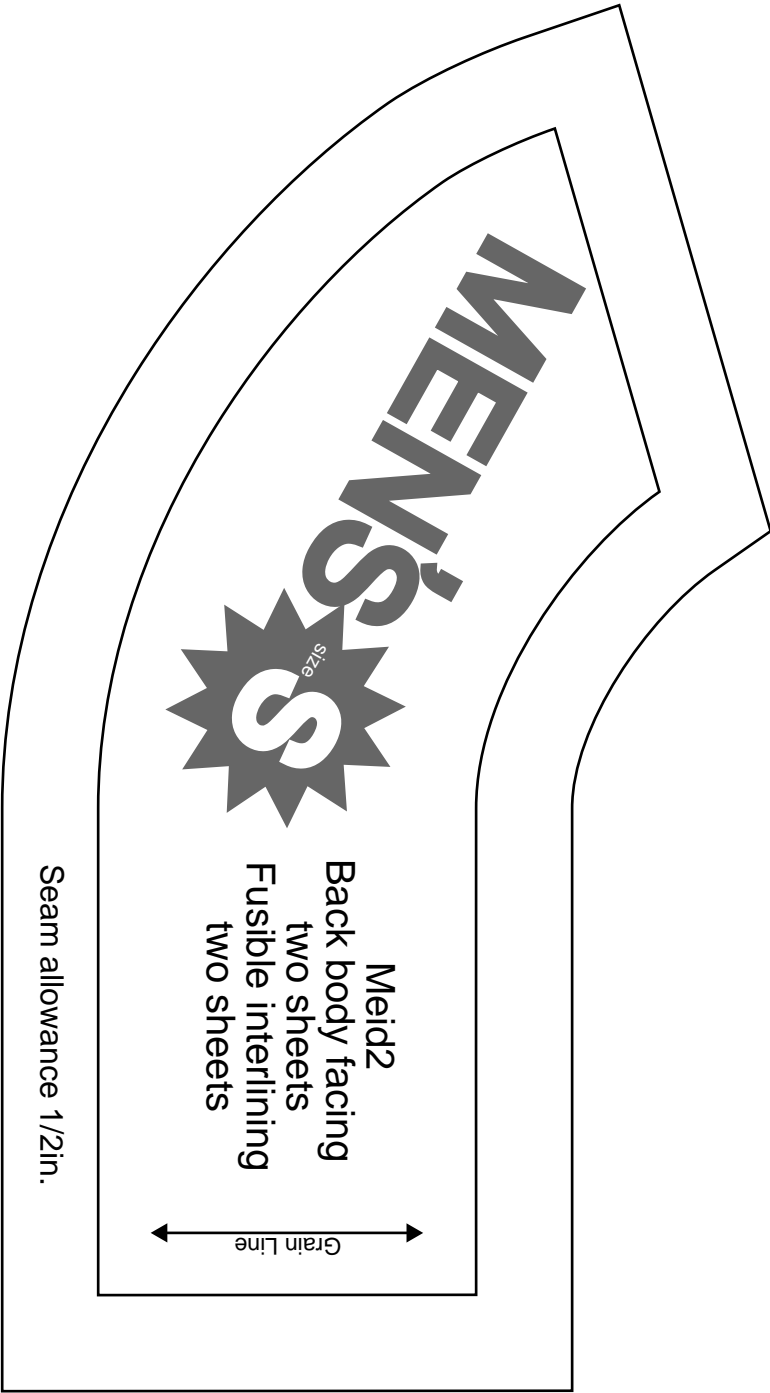

Bonding line BF

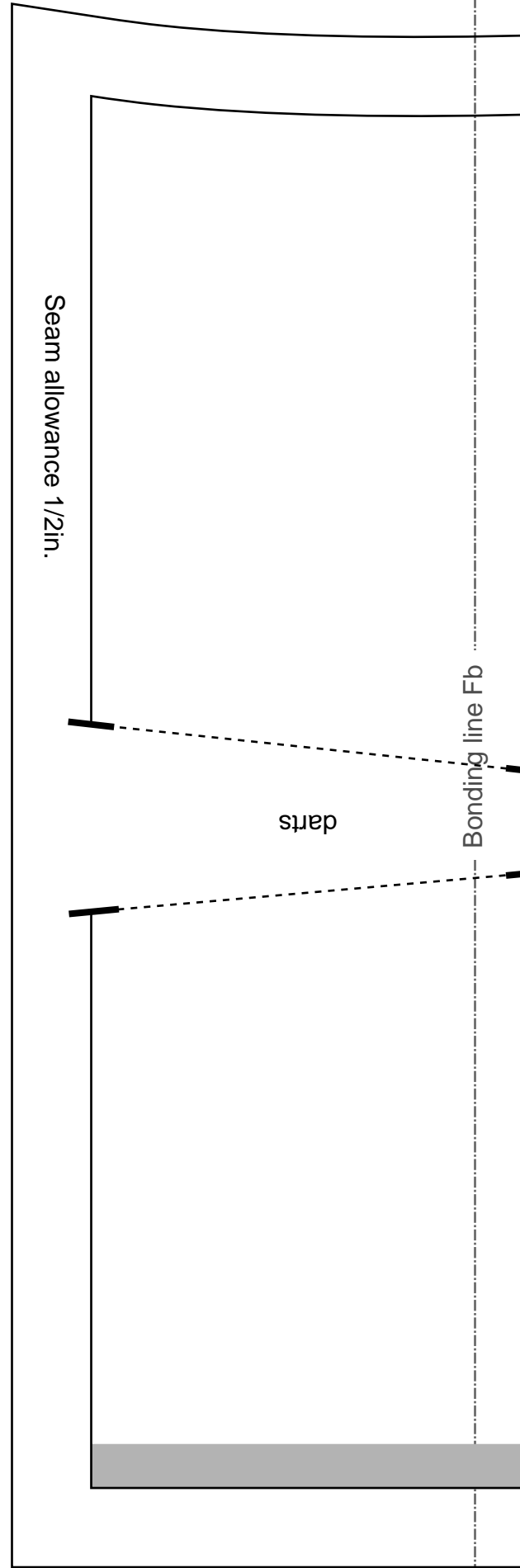

s
neets

MEN

Gathered frill race



Bonding line Ab

Bonding line Ac

Bonding line CA

Bonding line CA

Bonding line Bb



Bonding line Bc

Bonding line CB

Bonding line CB

Bonding line Cb

Bonding line Cc

Bonding line CC

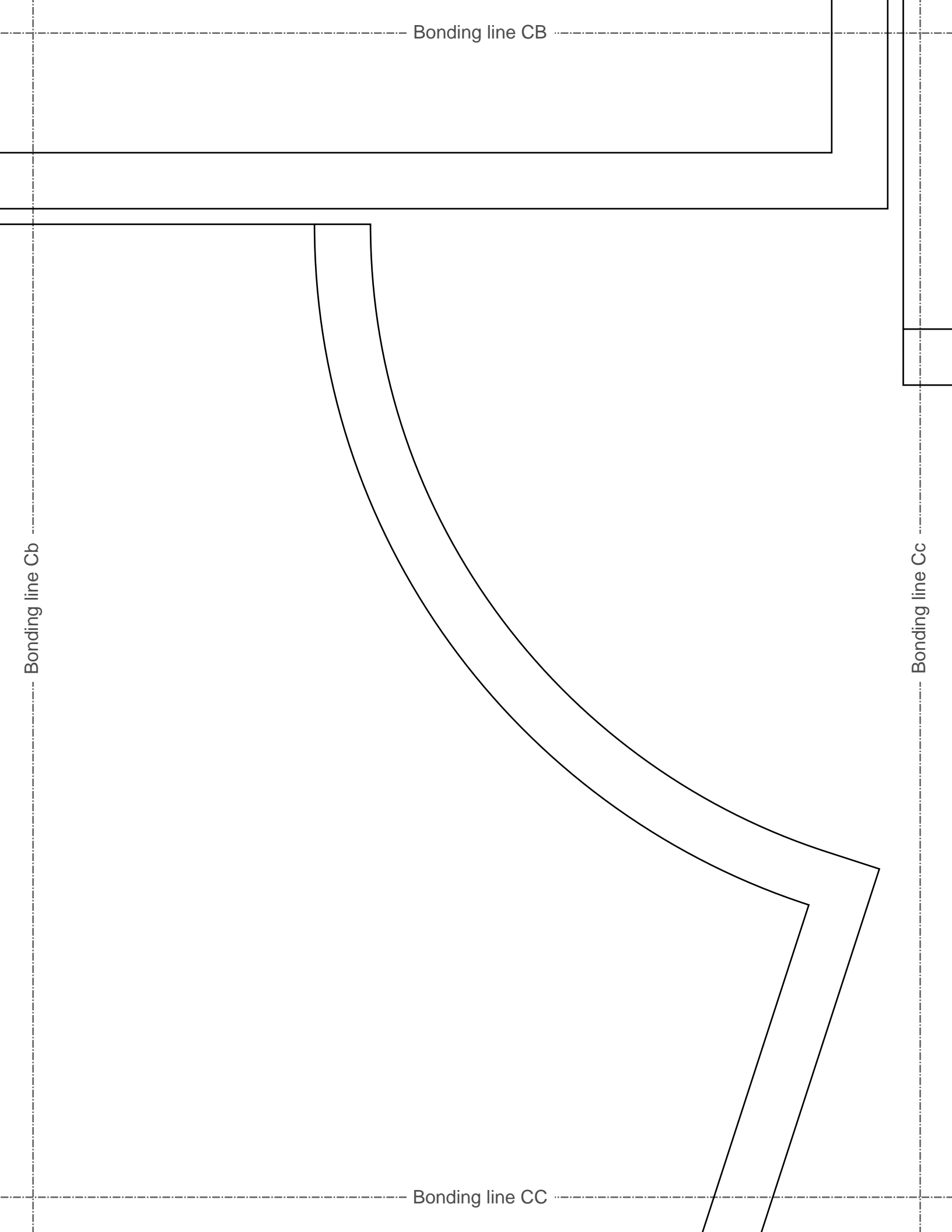

Bonding line CC

Bonding line Db

Bonding line Dc

Facing Line

Bonding line

DRCOS

SITE <http://dr-cos.info/en> <http://dr-cos.com/jp>
MAIL info@dr-cos.com
[/twitter.com/drcos_com](https://twitter.com/drcos_com) link.com/drcoscom

MEN'S

Bonding line Eb

Bonding line Ec

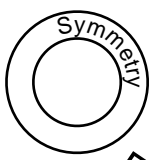

Meid2
Collar
two sheets
Fusible interlining
one sheets

nce 1/2in.

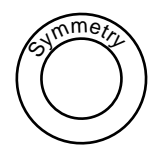
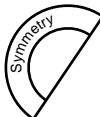

Meid2
Front body
one sheet

Bonding line CE

MENS S

size

Meid2
Back body
two sheets

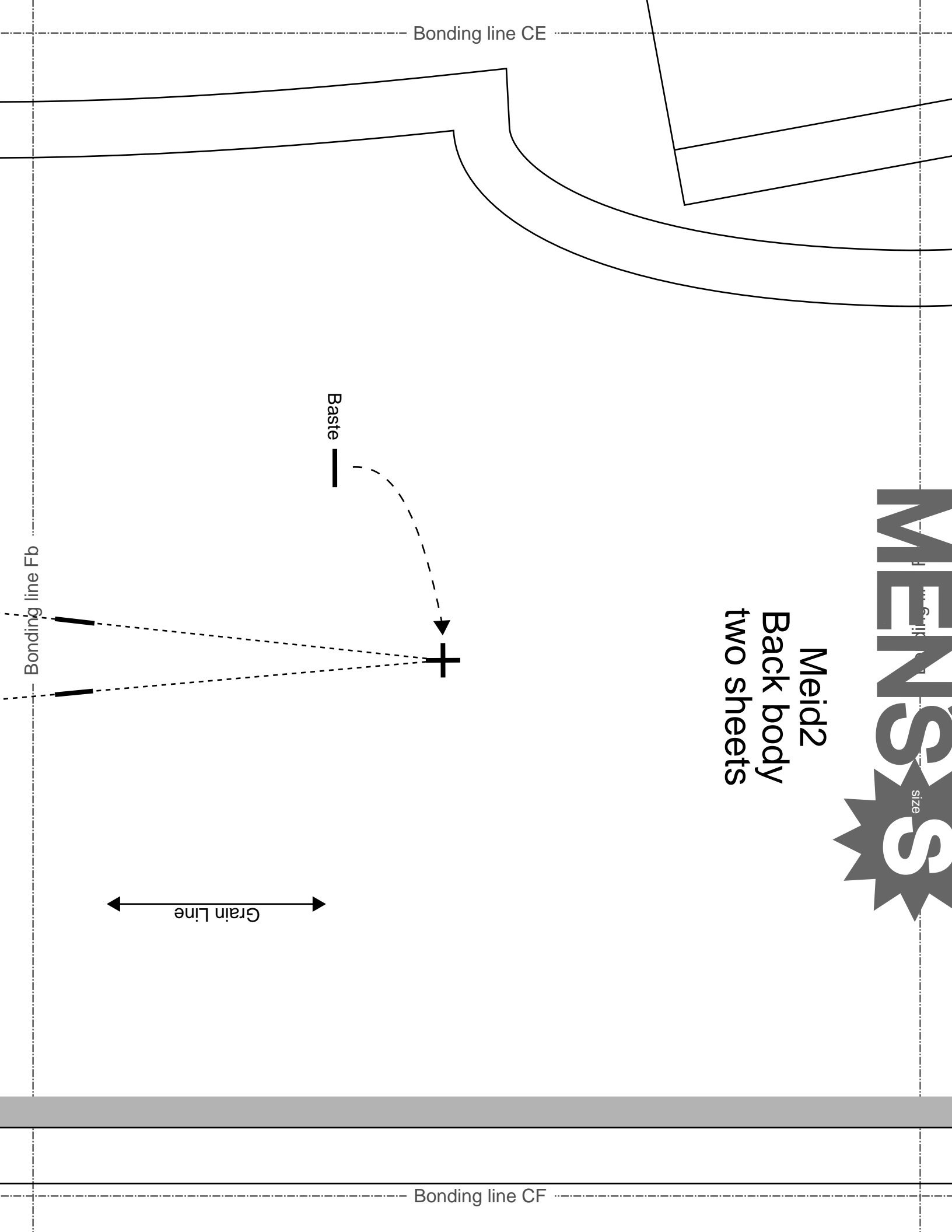

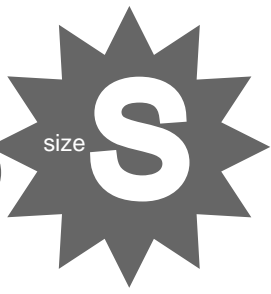
WOMEN'S  size S

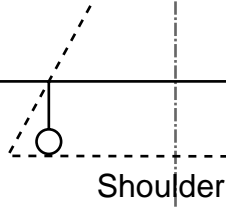

Bonding line Ac

Bonding line Ad

Bonding line DA

Bonding line DA

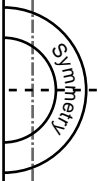

Bonding line Bc

Bonding line Bd

Bonding line DB

Bonding line DB

Bonding line Cc

Bonding line Cd

Bonding line DC

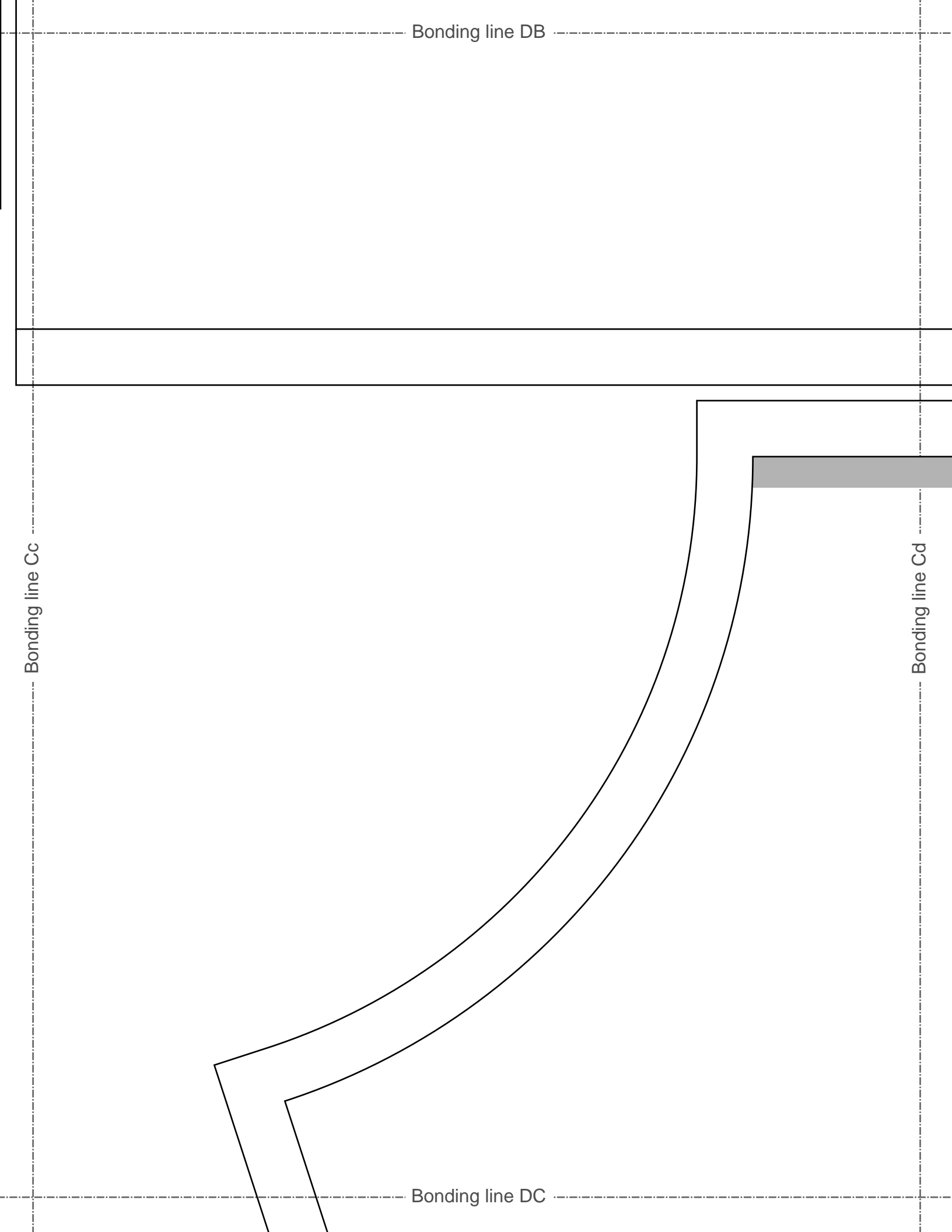

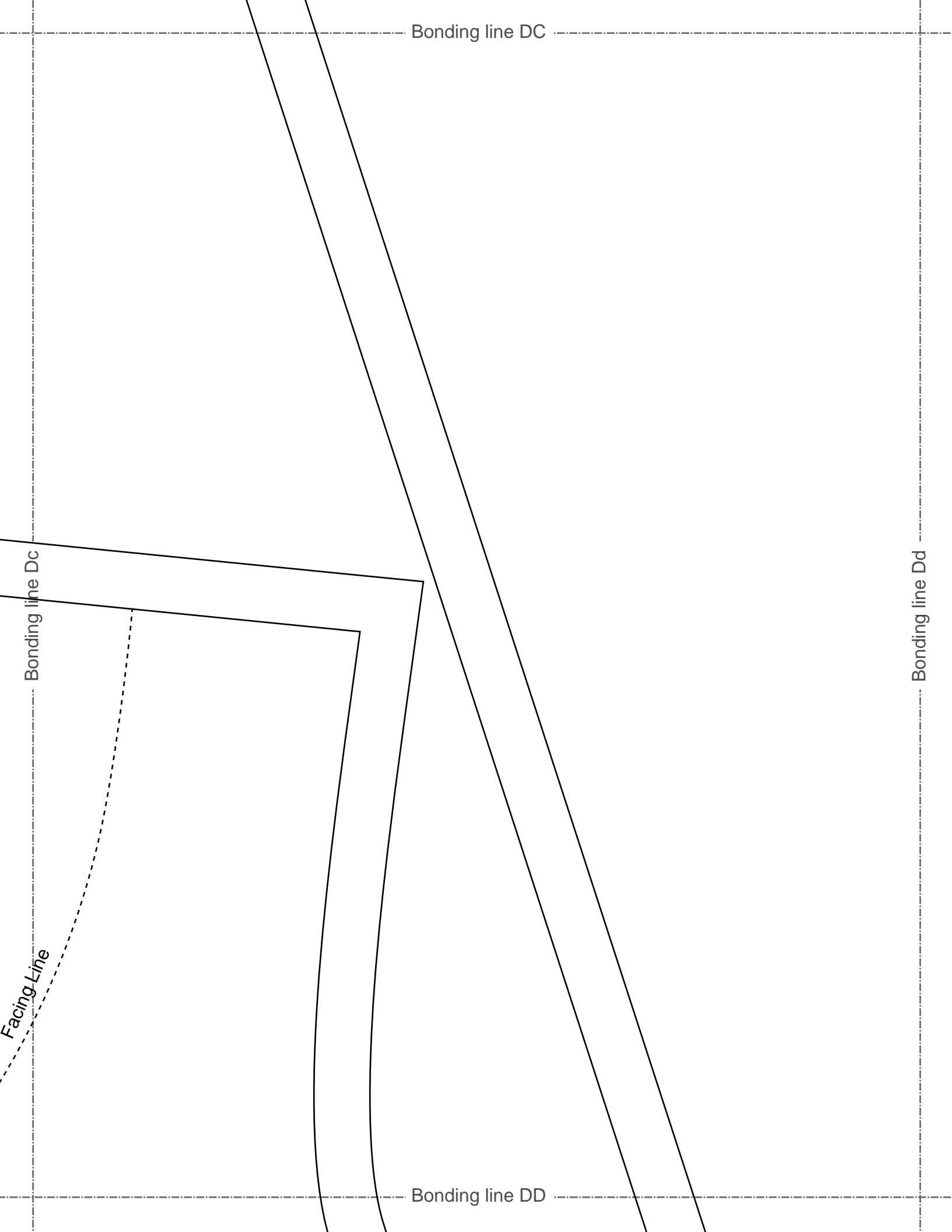

Bonding line DC

Bonding line Dc

Bonding line Dd

Bonding line DD

Facing Line

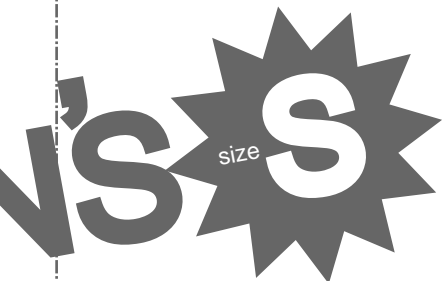

Bonding line DD

Bonding line Ec

12
body
sheets



darts



darts



Grain Line

Bonding line DE
Seam allowance 1/2in.

Bonding line Ed

DRCOS

SITE <http://dr-cos.info/en> <http://dr-cos.com/jp>
MAIL info@dr-cos.com

Bonding line DF
Seam allowance 1/2in.

DRCOS
SITE <http://drcos.info/en> <http://drcos.com/p>
MAIL info@drcos.com
Twitter https://twitter.com/drcos_com
facebook <https://www.facebook.com/drcoscom>

Facing Line

Spring hook

Bonding line DF

Bonding line Fd

MEN'S
size

Shoulder strap position



Velcro

Bonding line Ad

Bonding line Ae

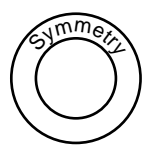

Meid2
Ribbon lower part
one sheets

Bonding line EA

Bonding line EA

Bonding line Bd

Bonding line Be

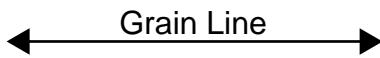

Bonding line EB

Bonding line EB

Gathered frill race

Bonding line Cd

Zip position ○

Bonding line Ce

Bonding line EC



Bonding line Dd

Bonding line EC

MEN'S  **S**
size

Meid2
front skirt
two sheets

Bonding line ED

Bonding line De

DRCOS

SITE <http://dr-cos.info/en> <http://dr-cos.com/jp>
MAIL info@dr-cos.com
Twitter [@dr-cos.com](https://twitter.com/dr-cos.com)
facebook <https://www.facebook.com/drcoscom>

Bonding line ED

Bonding line Ed

Seam allowa

Bonding line Ee

Bonding line EE

Grain Line

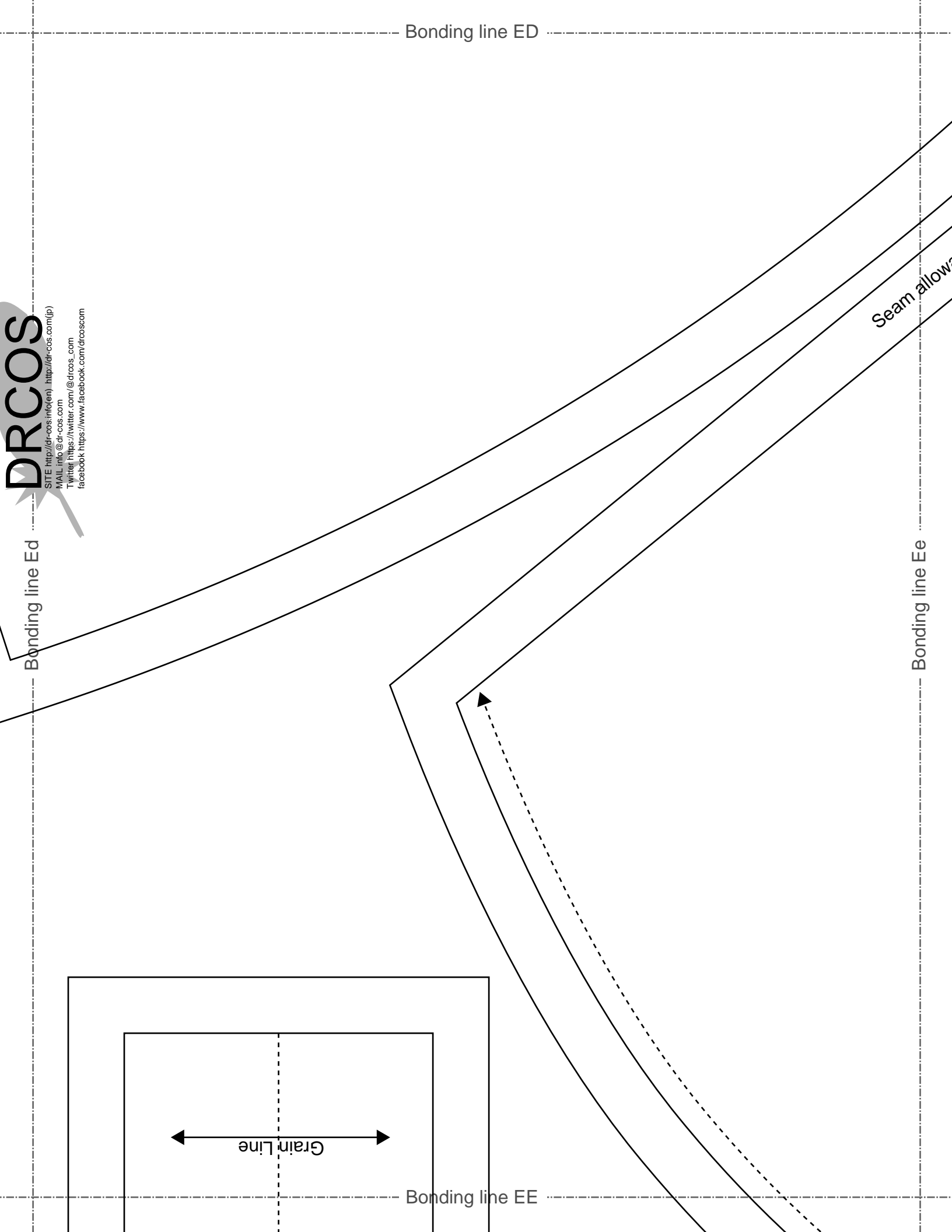
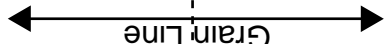

Bonding line EE

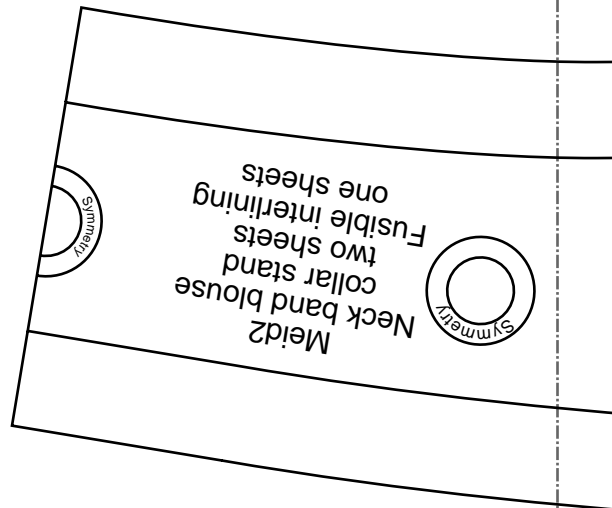
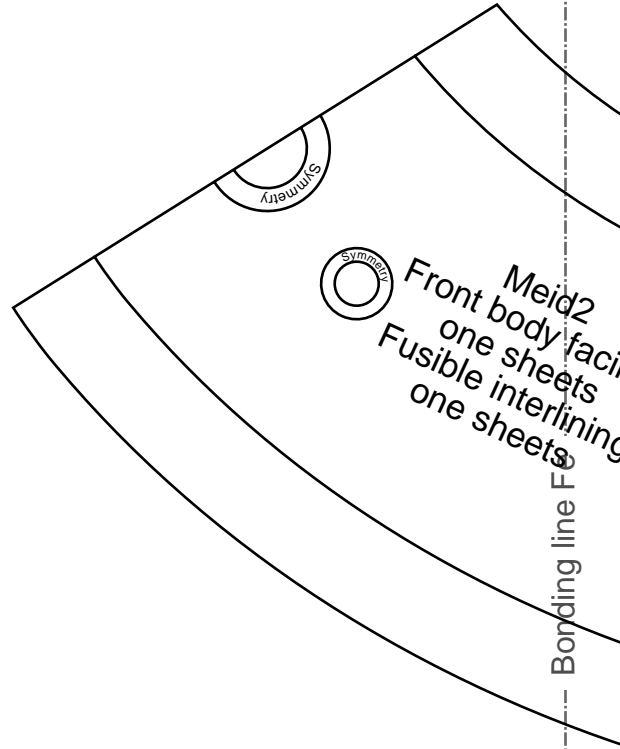

Bonding line F

Bonding line EF

Meid2
cuffs two sheets
Fusible interlining two sheets

Seam allowance 1/2in.



DRCOS
 SITE <http://dr-cos.info/en> <http://dr-cos.com/jp>
 MAIL info@dr-cos.com
 Twitter <https://twitter.com/drcos>
 facebook <https://www.facebook.com/drcoscom>

Bonding line Fd

Bonding line Ae

Bonding line Af

Bonding line FA

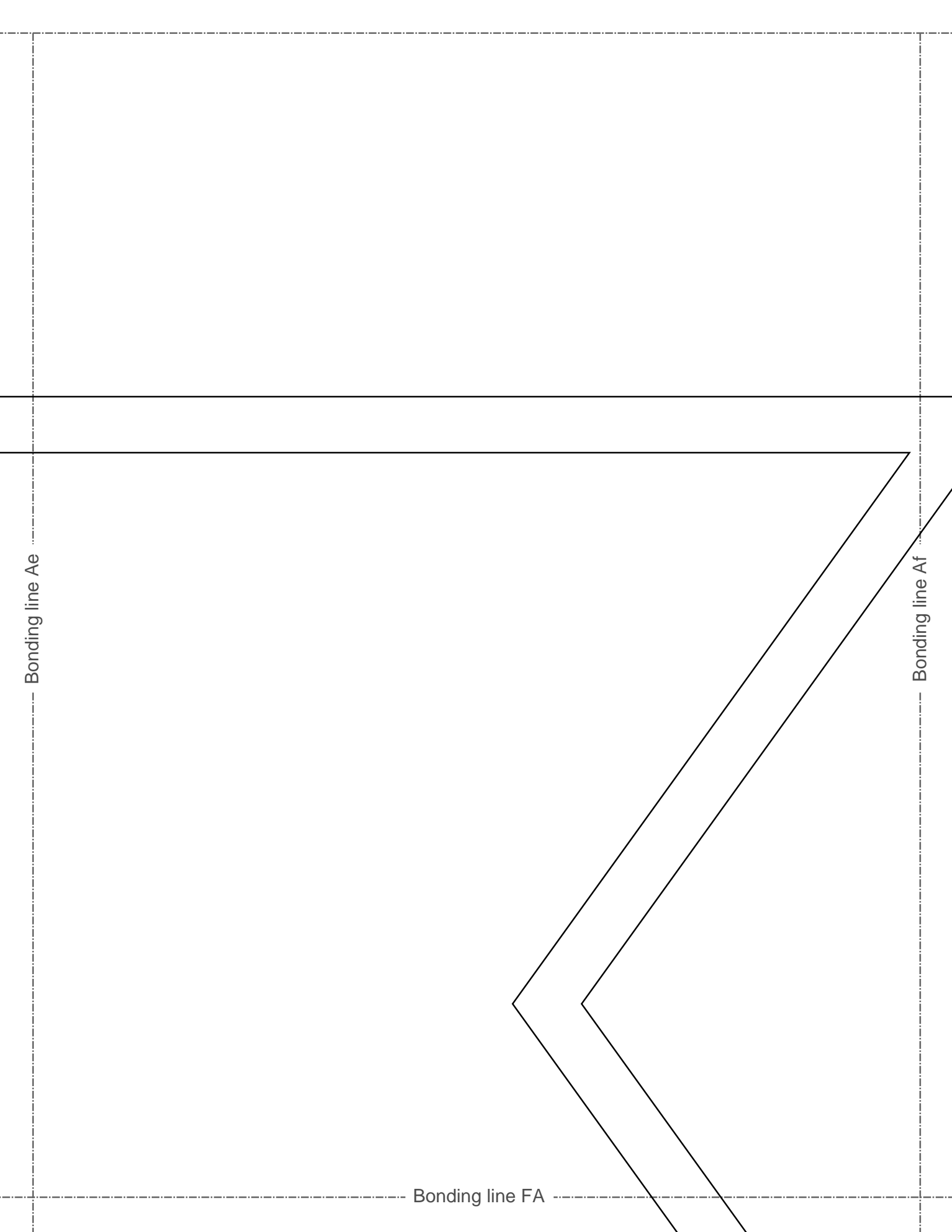

Bonding line FA

Bonding line Be

Bonding line Bf

DRCOS

SITE <http://dr-cos.info/en> <http://dr-cos.com/jp>
MAIL info@dr-cos.com
Twitter [@drcos_com](https://twitter.com/@drcos_com)
facebook <https://www.facebook.com/drcoscom>

Bonding line FB

Bonding line FB

Bonding line Ce

Bonding line Cf

Grain Line

Bonding line FC

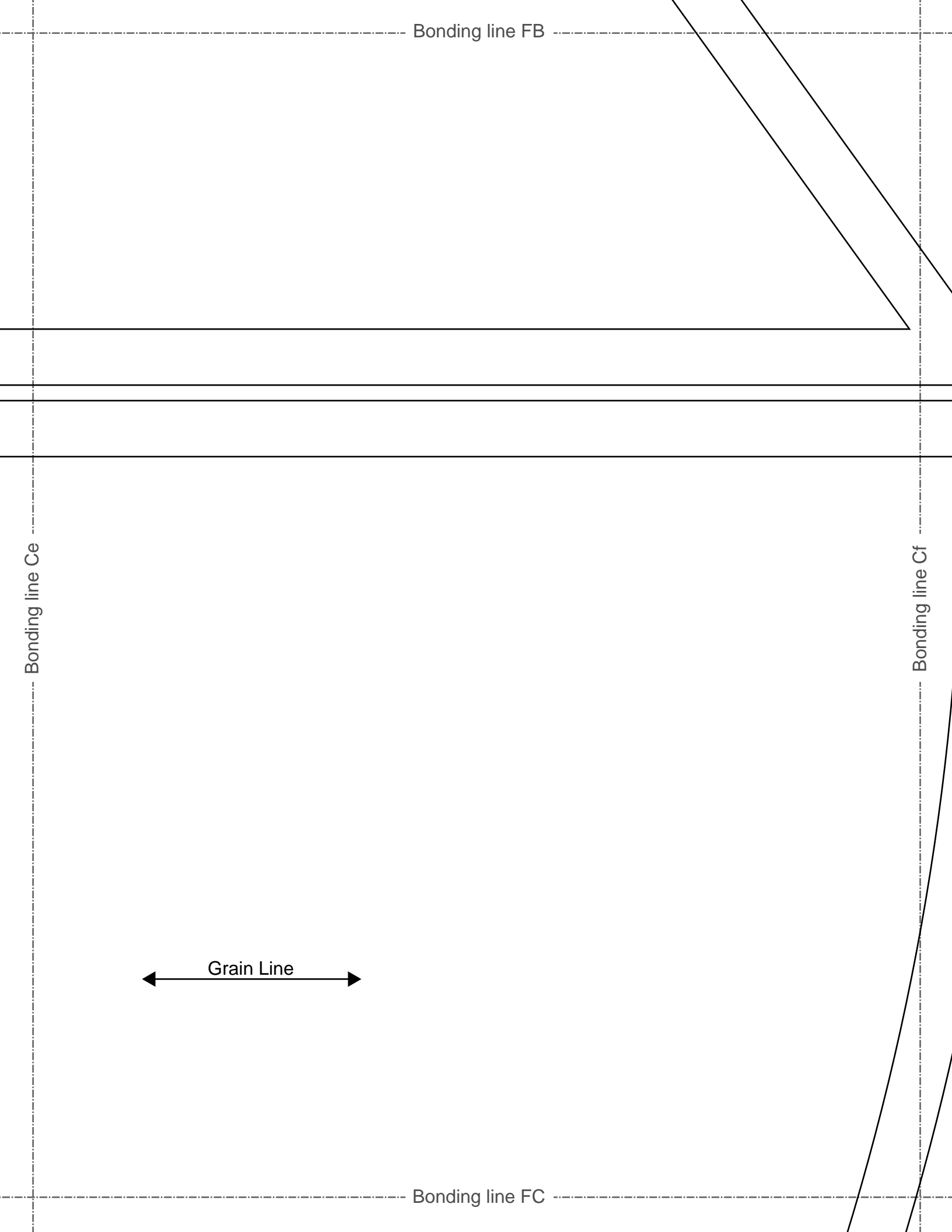

Bonding line FC

Bonding line De

Bonding line Df

Seam allowance 1/2in.

Bor

DRCOS

info@drkos.com
http://drkos.com(ip)

FD

info@drkos.com
http://drkos.com



eam allowance 1/2in.

Bonding line Ee

Bonding line Ef

MEN'S size **S**
Meid2
Apron lower part
two sheets

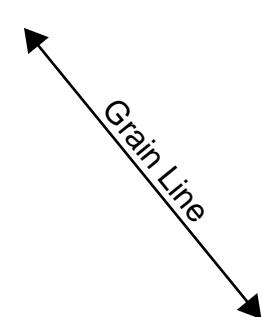

Bonding line FE

face

Bonding line FE

Gathered frill race

Body facing
interlining
sheets

Bonding line Ff

MEN'S size **S**

Grain Line

DRCOS

SITE <http://dr-cos.info/en> <http://dr-cos.com/p>
MAIL info@dr-cos.com
Twitter https://twitter.com/dr-cos_com
facebook <https://www.facebook.com/drcoscom>

Seam allowance 1/2in.

Bonding line Ff

Seam allowance 1/2in.

MEN'S size **S**

Grain Line

Button position



Collar position



Bonding line FF

Bonding line Af

MEN'S
size
S

DRCOS
SITE <http://dr-cos.info/en> <http://dr-cos.com/jp>
MAIL info@dr-cos.com
Twitter <https://twitter.com/dracos>
facebook <https://www.facebook.com/drcoscom>

Bonding line Ca

MEN'S
size
S

DRCOS
SITE <http://dr-cos.info/en> <http://dr-cos.com/jp>
MAIL info@dr-cos.com
Twitter <https://twitter.com/dracos>
facebook <https://www.facebook.com/drcoscom>

Bonding line Ag

MEN'S
size
S

DRCOS
SITE <http://dr-cos.info/en> <http://dr-cos.com/jp>
MAIL info@dr-cos.com
Twitter <https://twitter.com/dracos>
facebook <https://www.facebook.com/drcoscom>

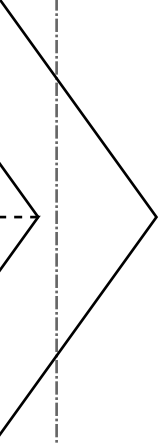

Bonding line Bf

Meid2
Apron shoulder strap gather frill
two sheets

ME

Bonding line CA

Meid2
Skirt hem gathered frill
four sheets

ME

Meid2
Apron lower part gathered frill
one sheets

ME

Bonding line Bg

Bonding line GB

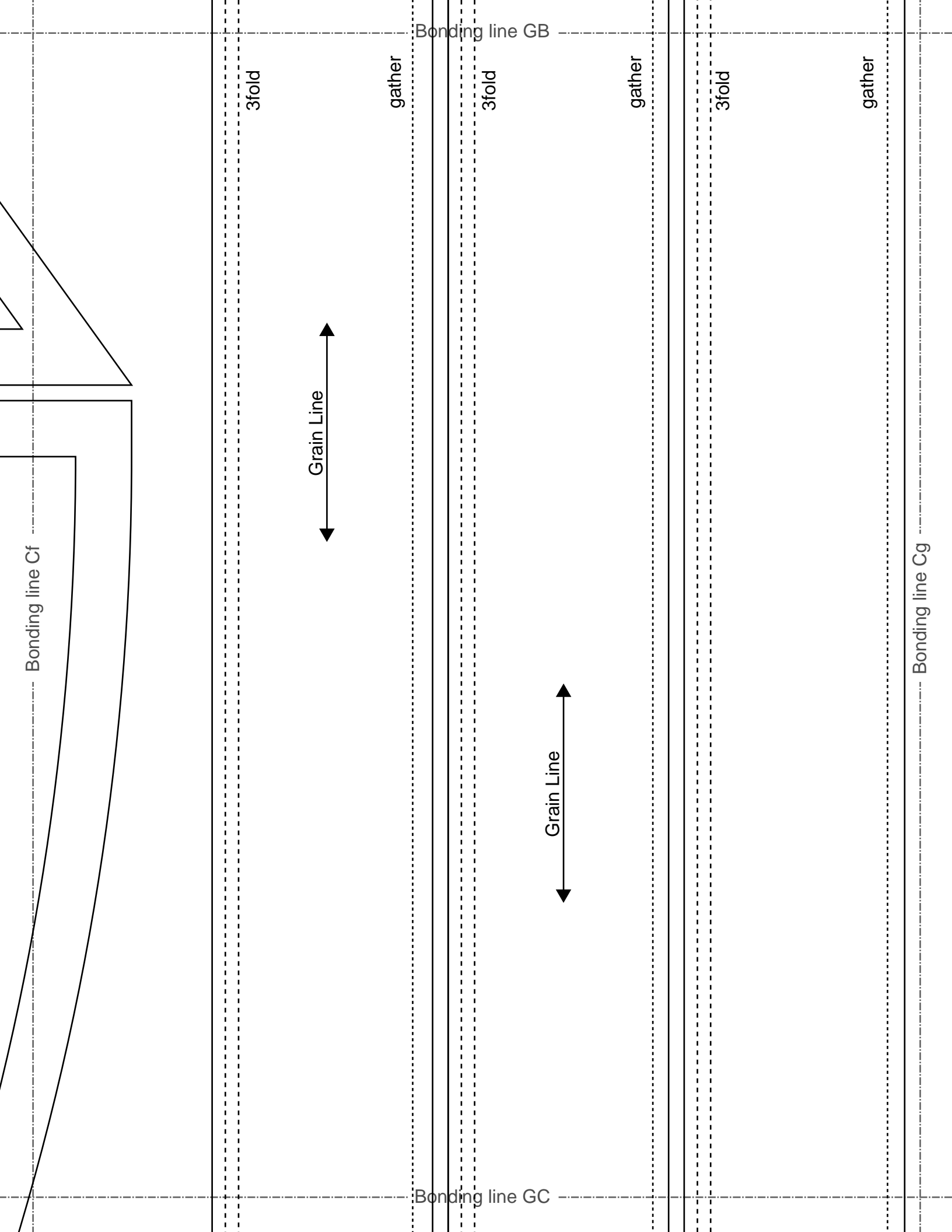

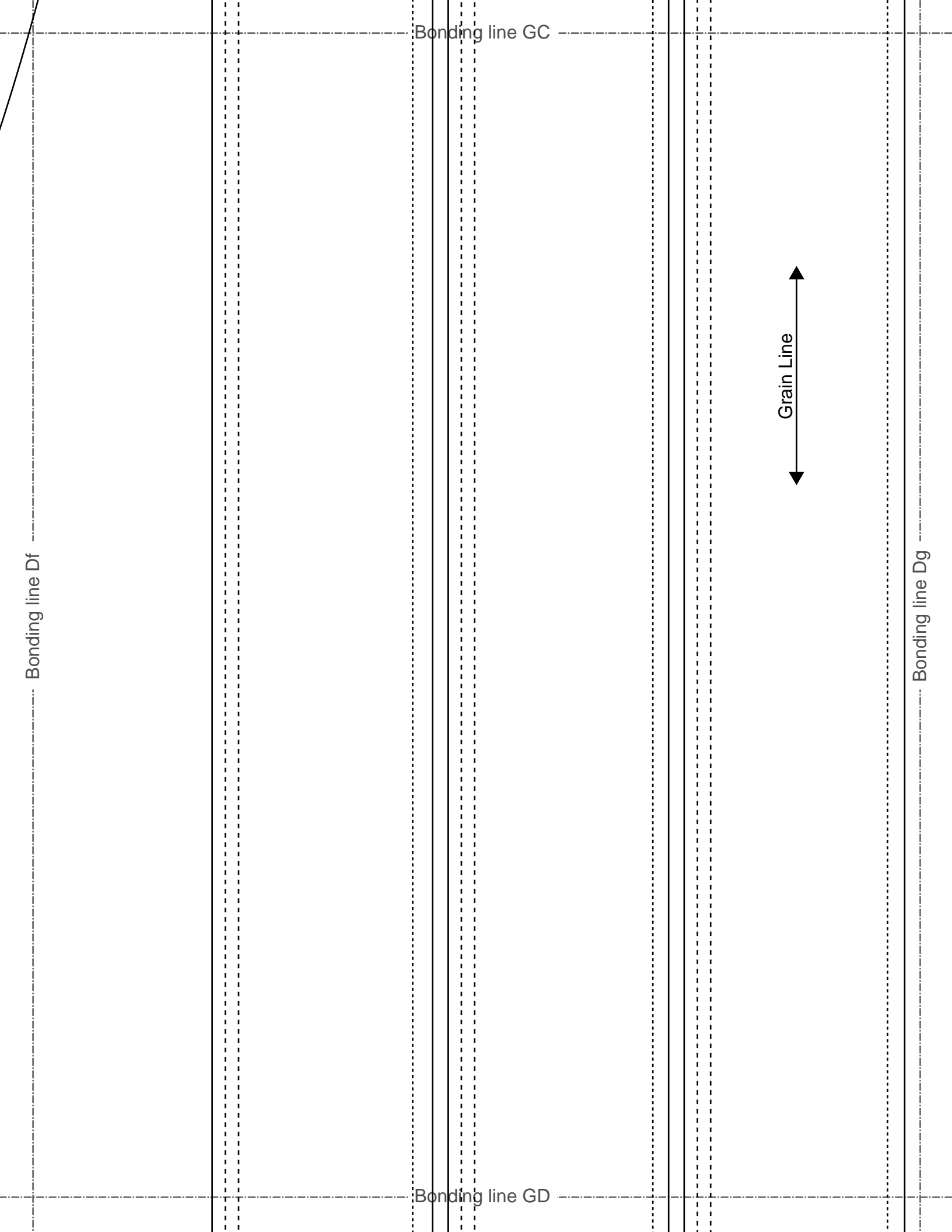

Bonding line Df

Bonding line GC

Bonding line GD

Bonding line Dg

Grain Line

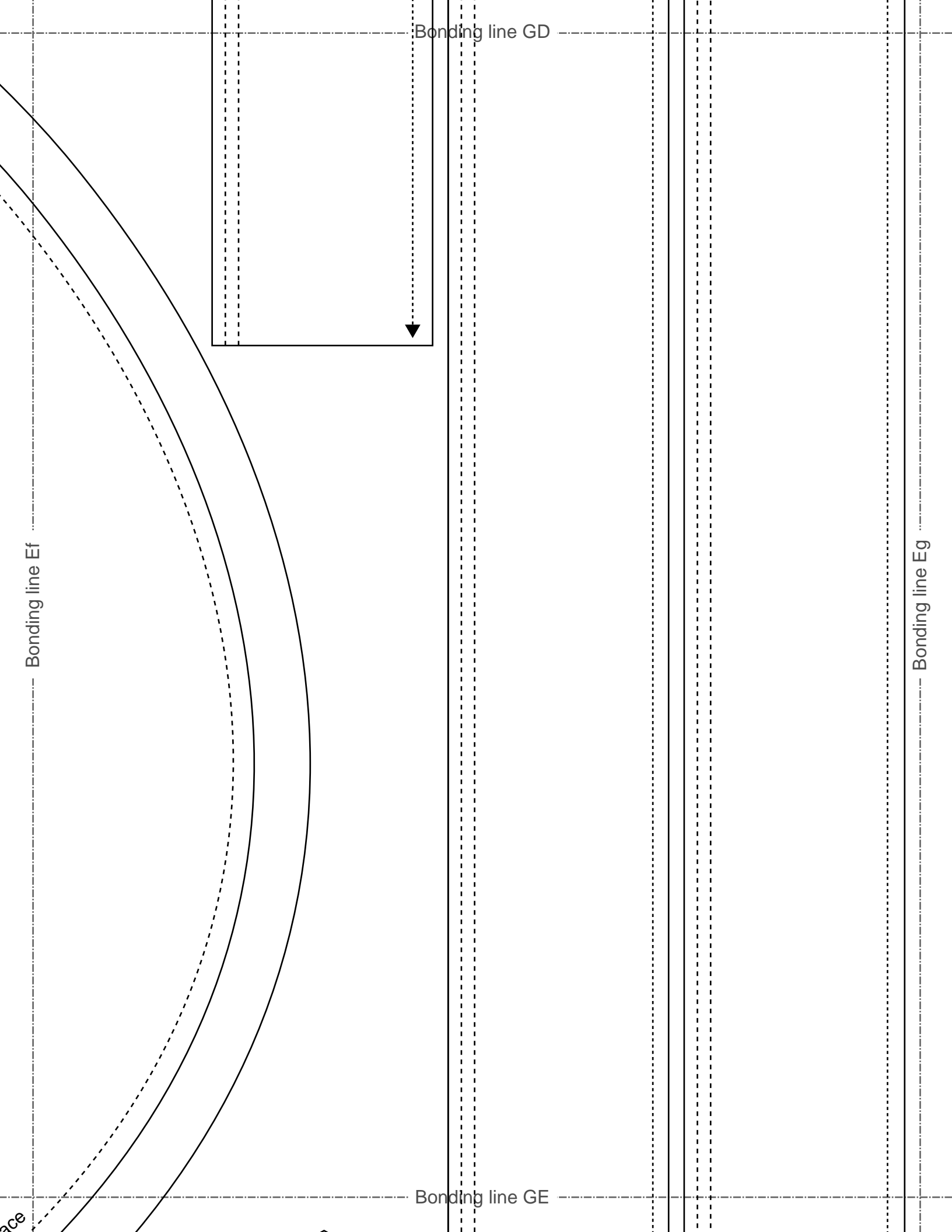

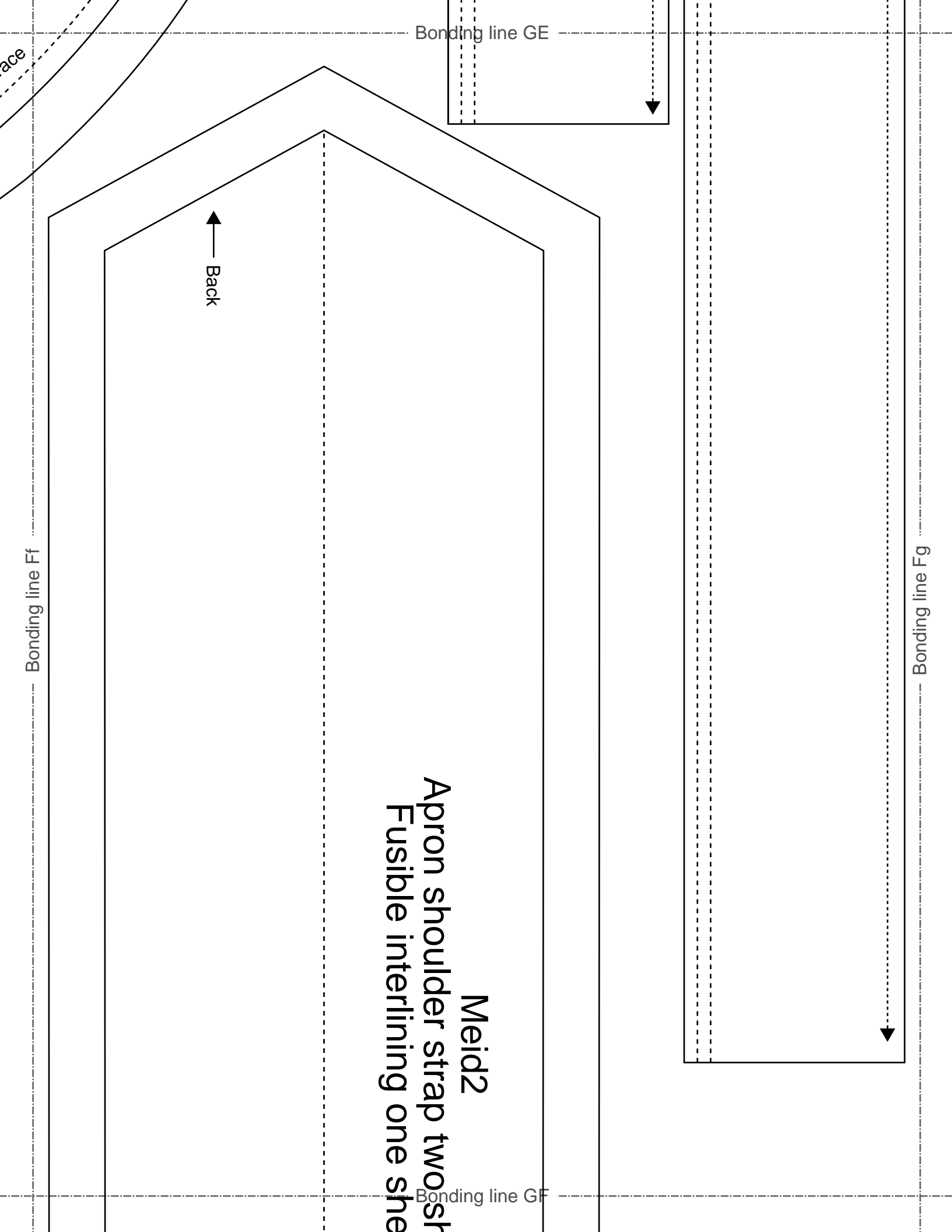

Boys' sheets
Boys' sheets

Bonding line Gf

MEN'S
size
S

Bonding line Gg

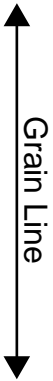

Gathered frill race

Bonding line Gf

Bonding line Gg

Bonding line GG

Bonding line Hf

Front →



Bonding line Hg

Shoulder strap position

Grain Line ← → Bonding line GH

position



Shoulder strap position

MEN'S size S

Meid2
Apron top parts
two sheets

Bonding line GH
 Grain Line

Seam allowance 1/2in.

Bonding line lf

Bonding line lg