

Bonding line AA

Bonding line Aa

Bonding line AA

LADIE

Jinba
Bod
two sh

Bonding line Ba

Bonding line AB

Bonding line AB



Seam allowance 1/2in.

Bonding line AC

Bonding line Ca

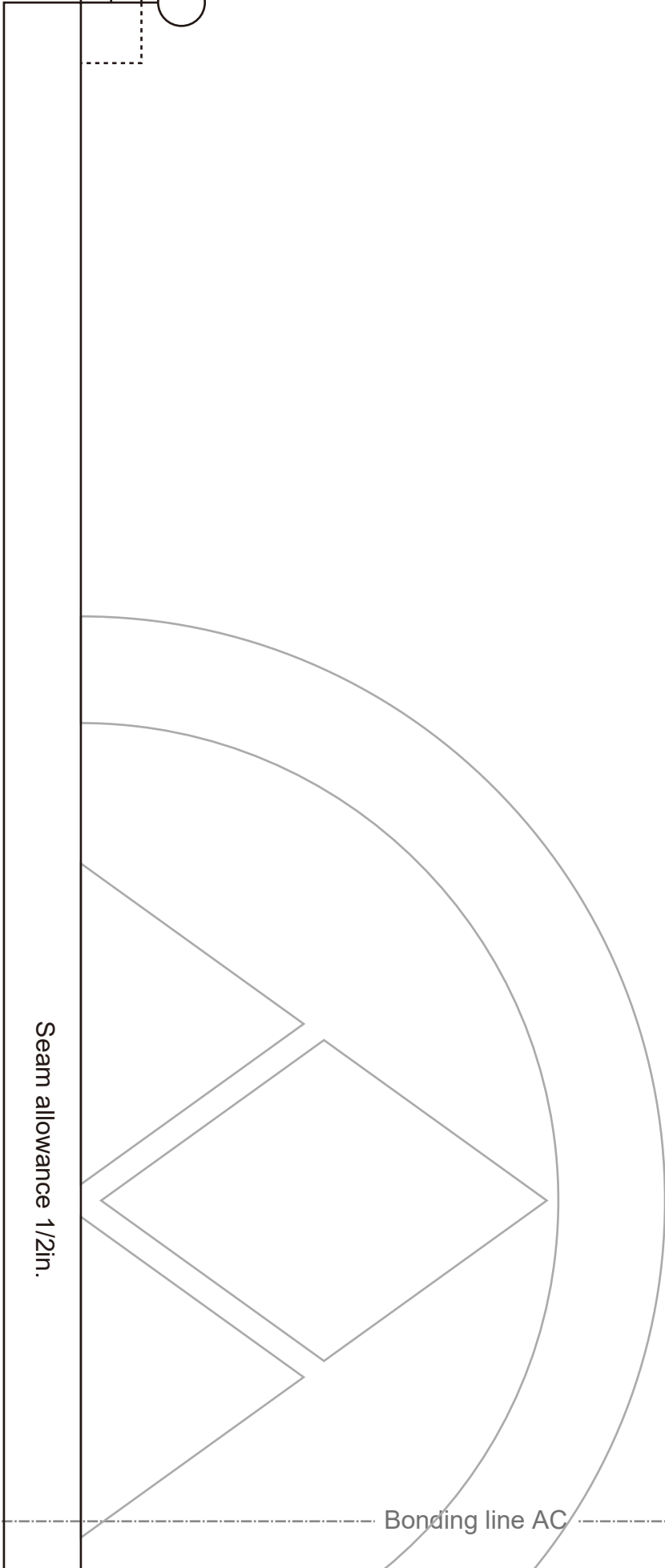

Bonding line AC

Bonding line Da

Bonding line AD

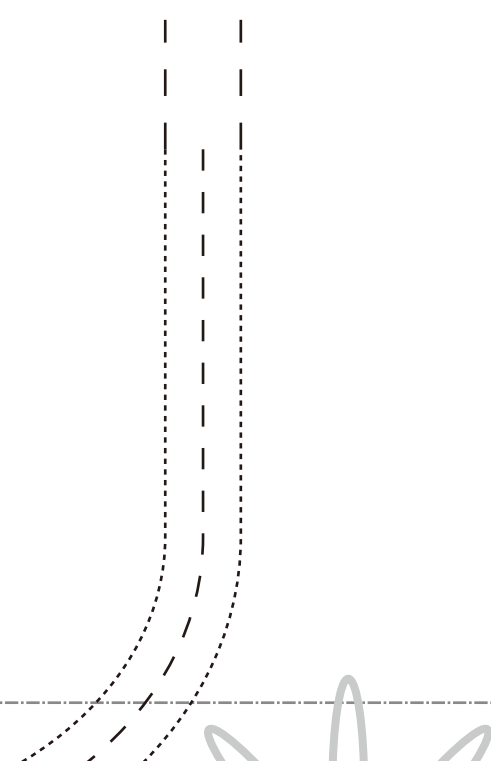
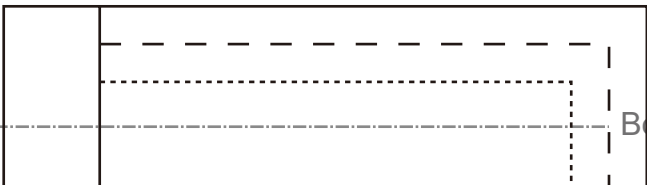

Jinbaori
Lower collar two sheets
Fusible interlining one sheets

LAI

Bonding line AD

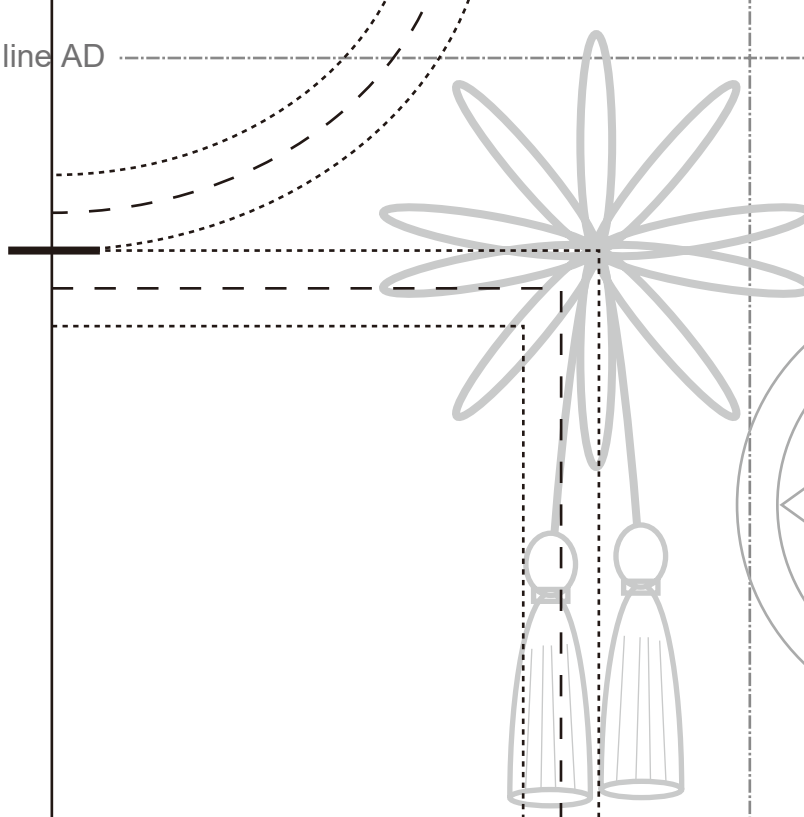

Bonding line Ea

Bonding line AE



Bais

Bonding line AE

Bonding line AF



Seam allowance 1/2in.

Bonding line Fa

Bonding line AF

SITE <http://dr-cos.info/en> | <http://dr-cos.com/jp>
MAIL info@dr-cos.com
TWITTER https://twitter.com/drcos_com
FACEBOOK <https://www.facebook.com/drcoscom>

DRCOS

Bonding line Ga

Bonding line AG

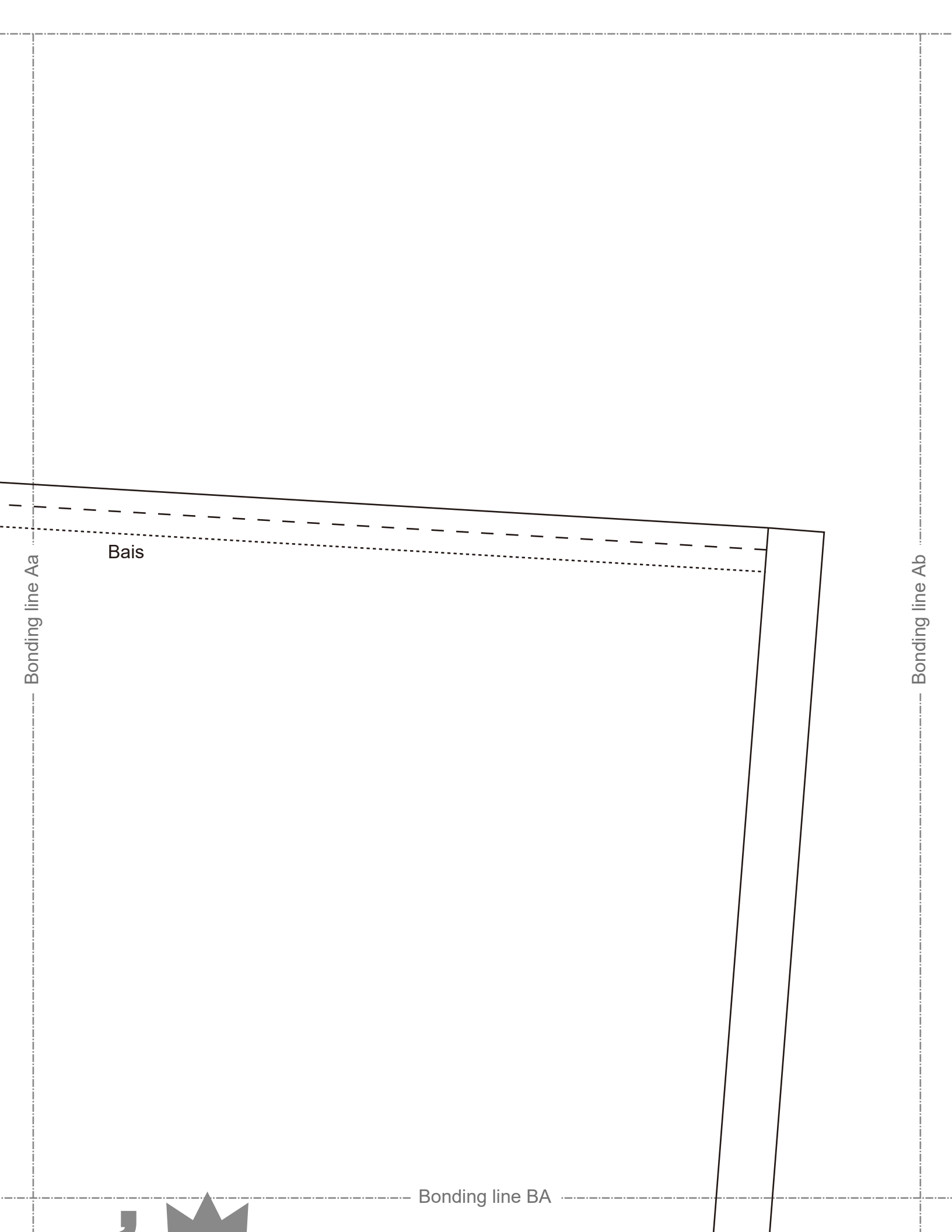

Bonding line Aa

Bais

Bonding line BA

Bonding line Ab

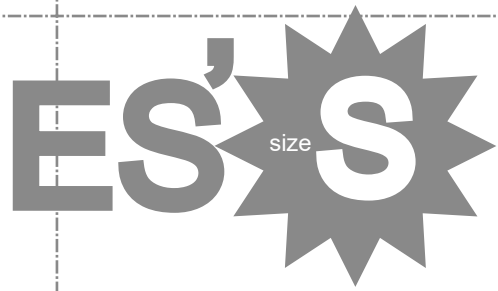

inbaori
Body
o sheets

Bonding line BA

Bonding line Ba

Seam allowance 1/2in.

Bonding line Bb

Bonding line BB

Bonding line BB

Bonding line Ca

Bonding line Cb

Bonding line BC

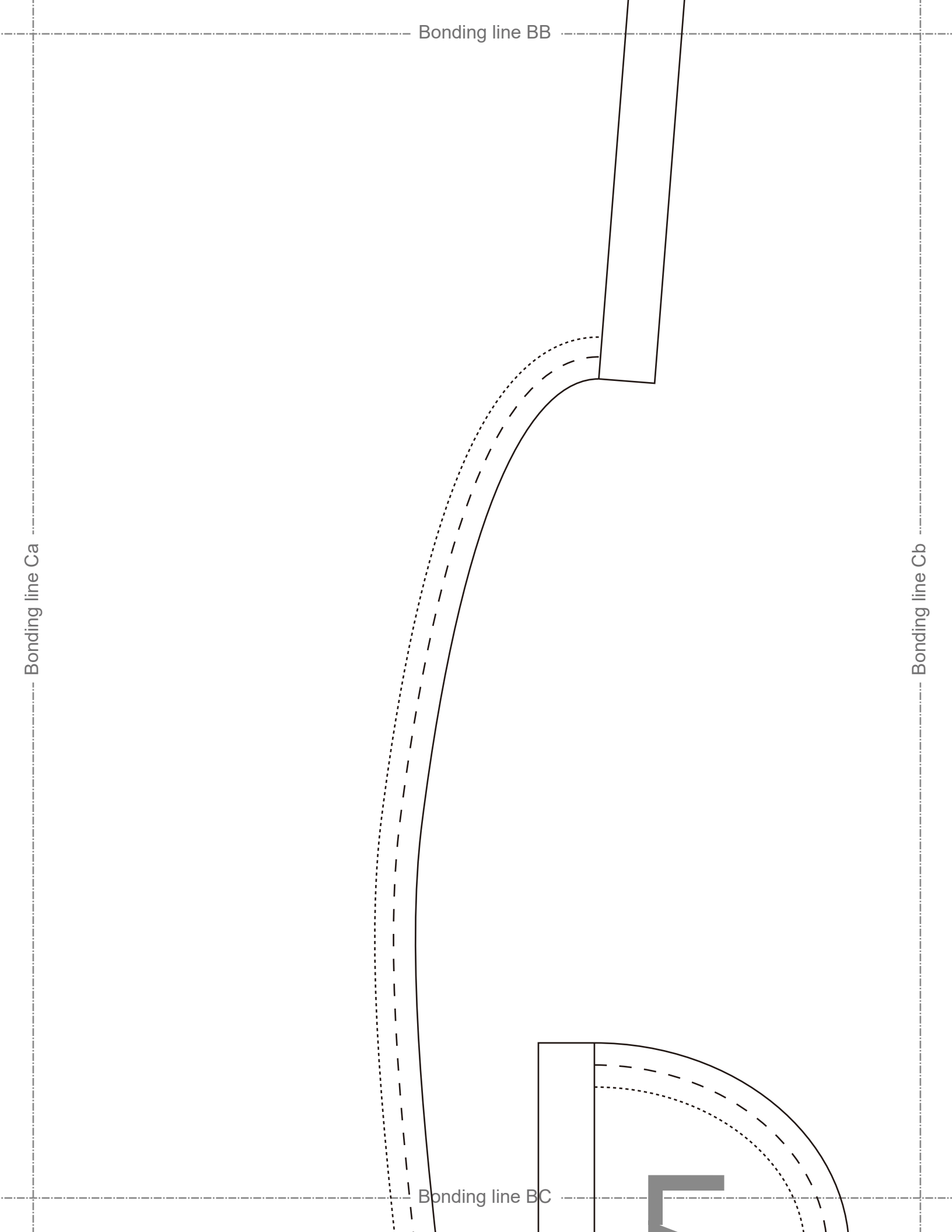

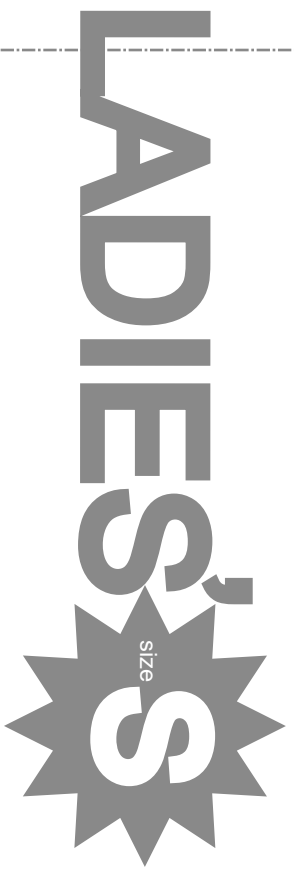

Jinbaori
Collar two sheets
Fusible interlining one sheets



Seam allowance 1/2in.

Bais

Bonding line BD

Bais

Bonding line BC

Bonding line Da

Bonding line Db

Bonding line BD

Grain Line

DRCOS
 SITE <http://dr-cos.info/en> <http://dr-cos.com/jp>
 MAIL info@dr-cos.com
 Twitter https://twitter.com/drcos_com
 facebook <https://www.facebook.com/drcoscom>

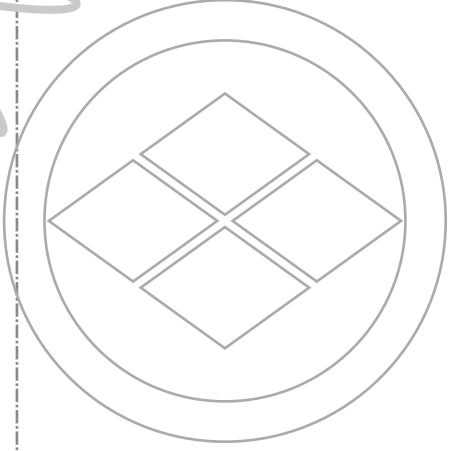

Bonding line Ea

Bonding line Eb

Bonding line BE

Bonding line Fa

Bonding line BE

Bonding line Fb

Bonding line BF



Seam allowance 1/2in.

Bonding line BF

Bonding line Ga

Bonding line Gb

Bais

DRCOS

SITE [http://dr-cos.info\(en\)](http://dr-cos.info(en)) [http://dr-cos.com\(jp\)](http://dr-cos.com(jp))
MAIL info@dr-cos.com
Twitter https://twitter.com/@drcos_com
facebook <https://www.facebook.com/drcoscom>

Bonding line BG