

[Home](#)

[Back to Front Button Dress page](#)

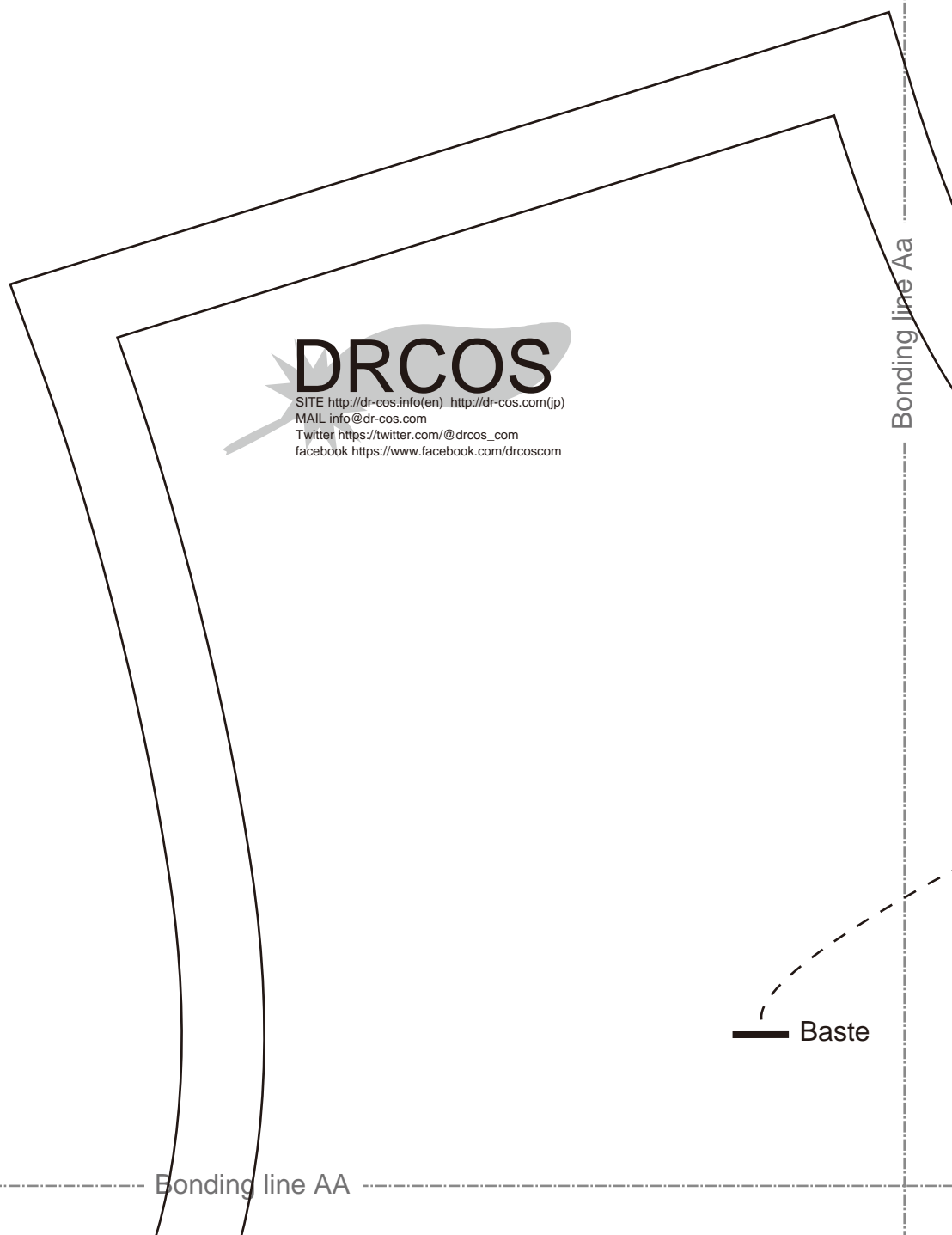

**DRCOS**

SITE [http://dr-cos.info\(en\)](http://dr-cos.info(en)) [http://dr-cos.com\(jp\)](http://dr-cos.com(jp))

MAIL [info@dr-cos.com](mailto:info@dr-cos.com)

Twitter [https://twitter.com/@drcos\\_com](https://twitter.com/@drcos_com)

facebook <https://www.facebook.com/drcoscom>

Bonding line Aa

 Baste

Bonding line AA

Bonding line AA

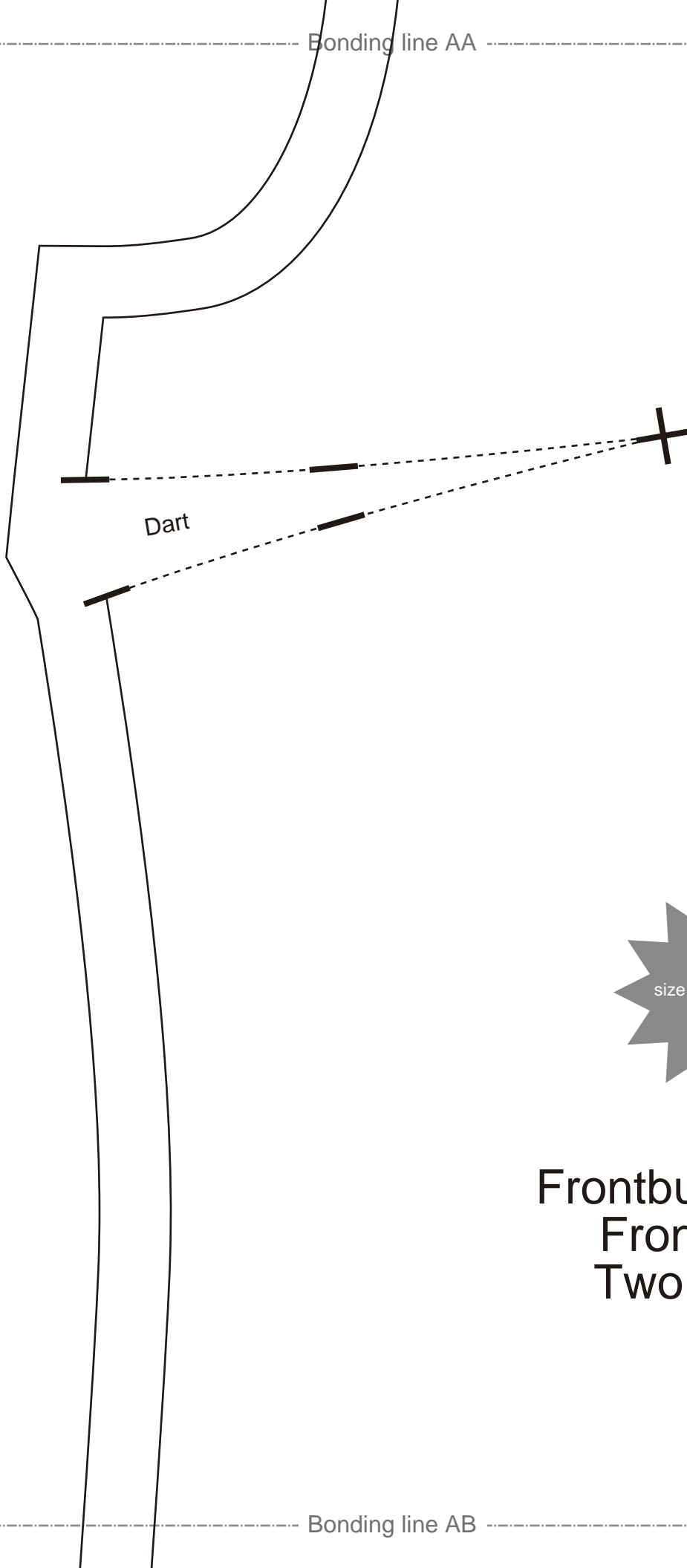

Dart

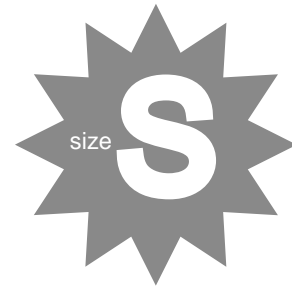

Frontbuttdress  
Front Body  
Two sheets

Bonding line AB

Bonding line Ba

Bonding line AB

Seam allowance 1/2in.

Bonding line AC

Bonding line Ca



Bonding line AC

Bonding line Da

Bonding line AD

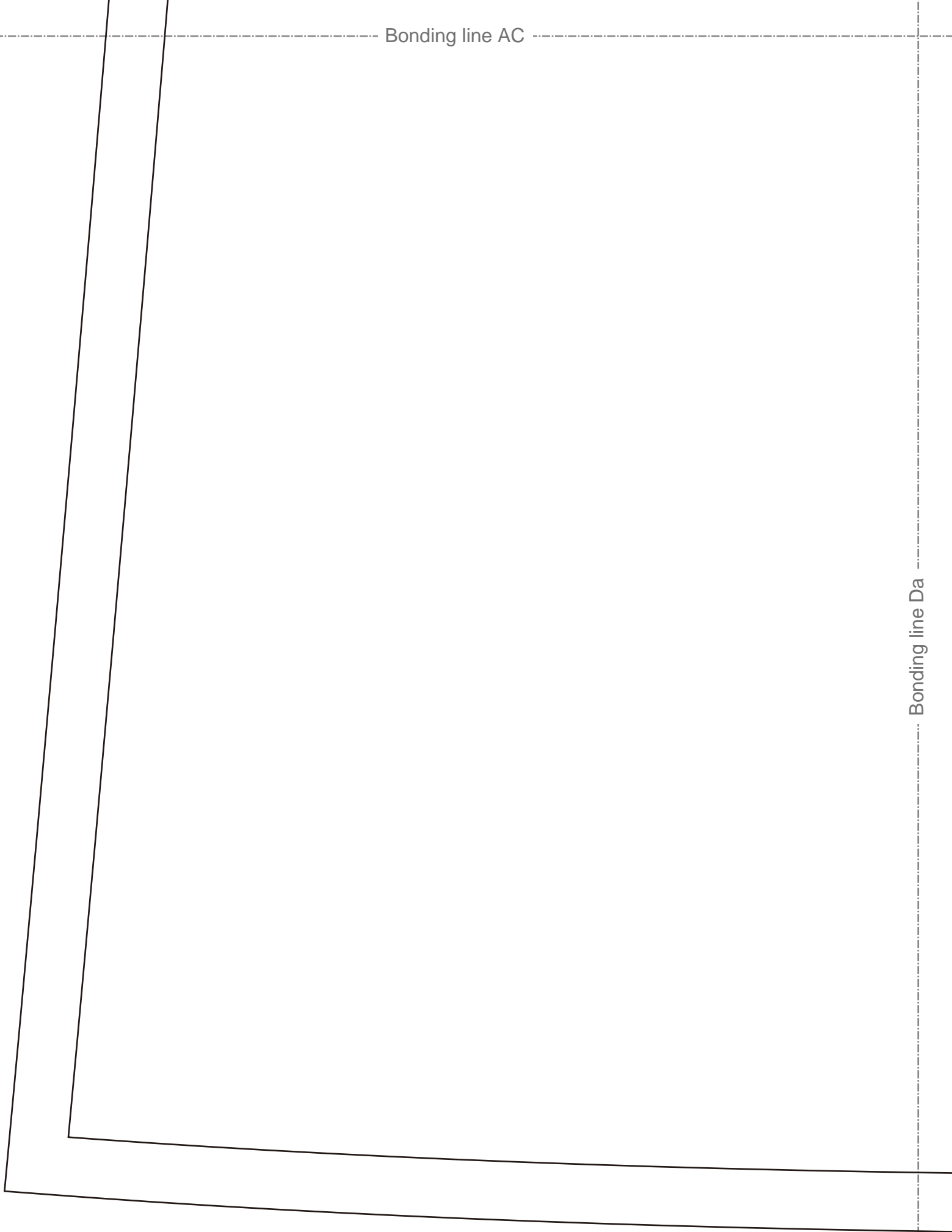

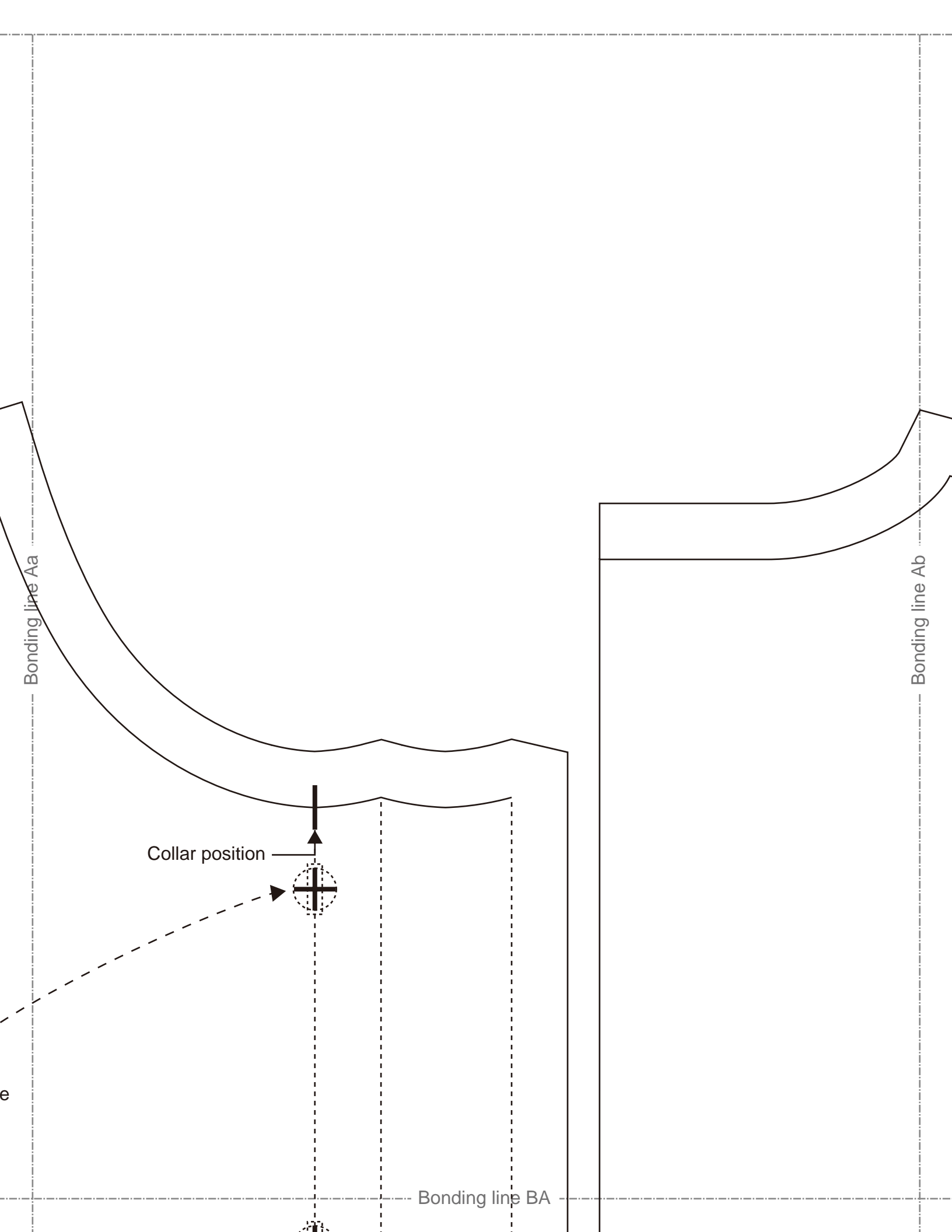

Bonding line Aa

Bonding line Ab

Collar position

Bonding line BA

e

Bonding line Ba

Button position



Bonding line BA

Bonding line BB



Bonding line Bb

Bonding line Ca

Bonding line BB

Trifold

Bonding line BC

Bonding line Cb



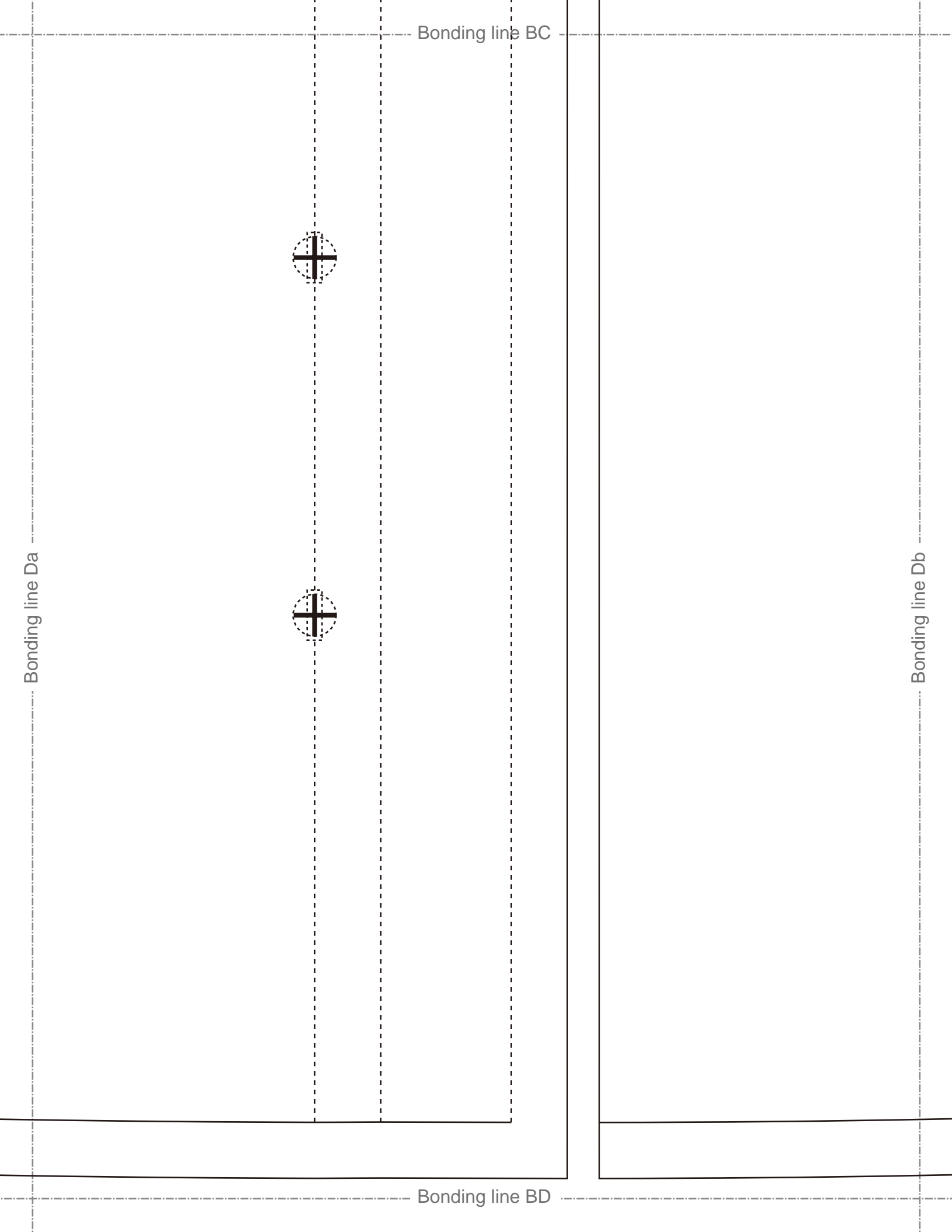

Bonding line BC

Bonding line Da

Bonding line Db

Bonding line BD



Bonding line Ab

Bonding line Ac

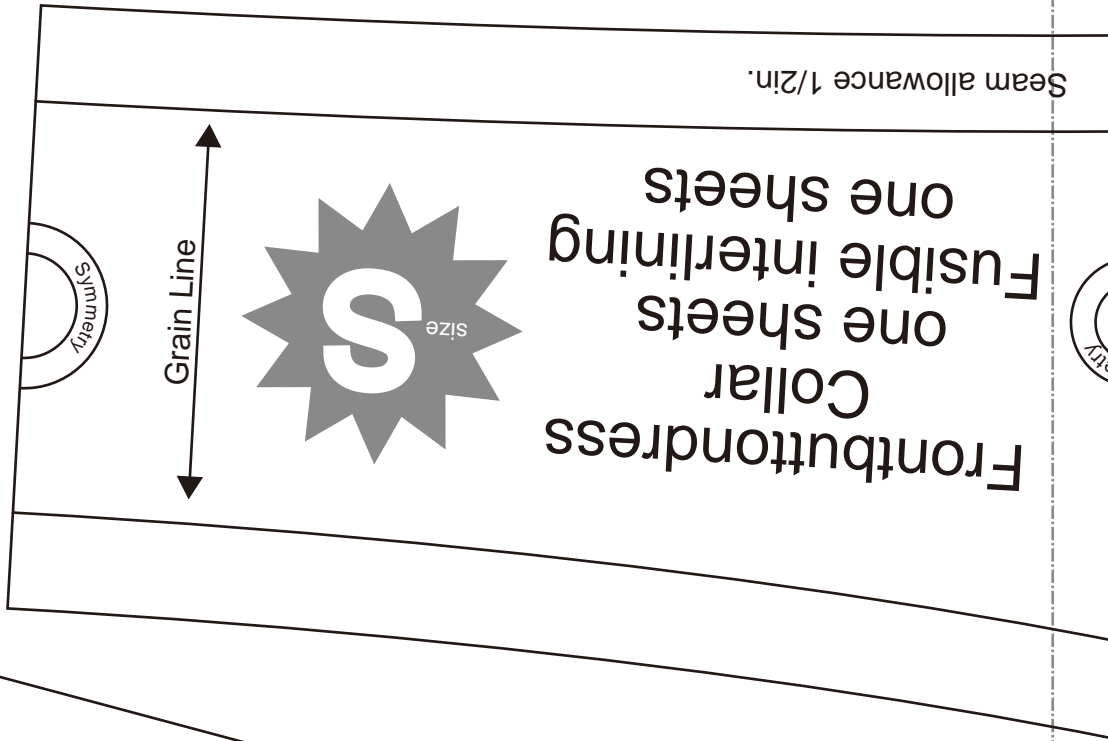

**DRCOS**  
 SITE [http://dr-cos.info\(en\)](http://dr-cos.info(en)) [http://dr-cos.com\(jp\)](http://dr-cos.com(jp))  
 MAIL [info@dr-cos.com](mailto:info@dr-cos.com)  
 Twitter [https://twitter.com/drcos\\_com](https://twitter.com/drcos_com)  
 facebook <https://www.facebook.com/drcoscom>

Bonding line CA

m(jp)

Bonding line CA

**DRCOS**  
SITE <http://drcos.info/en> <http://drcos.com/pt>  
MAIL [info@drcos.com](mailto:info@drcos.com)



Frontbuttdress  
Back Body  
one sheets



Bonding line Bb

Bonding line Bc

Bonding line CB

Bonding line CB

Bonding line Cb



Grain Line

Bonding line CC

Bonding line Cc

Seam allowance 1/2in.

Bonding line CC

Bonding line Db

Bonding line Dc

Bonding line CD

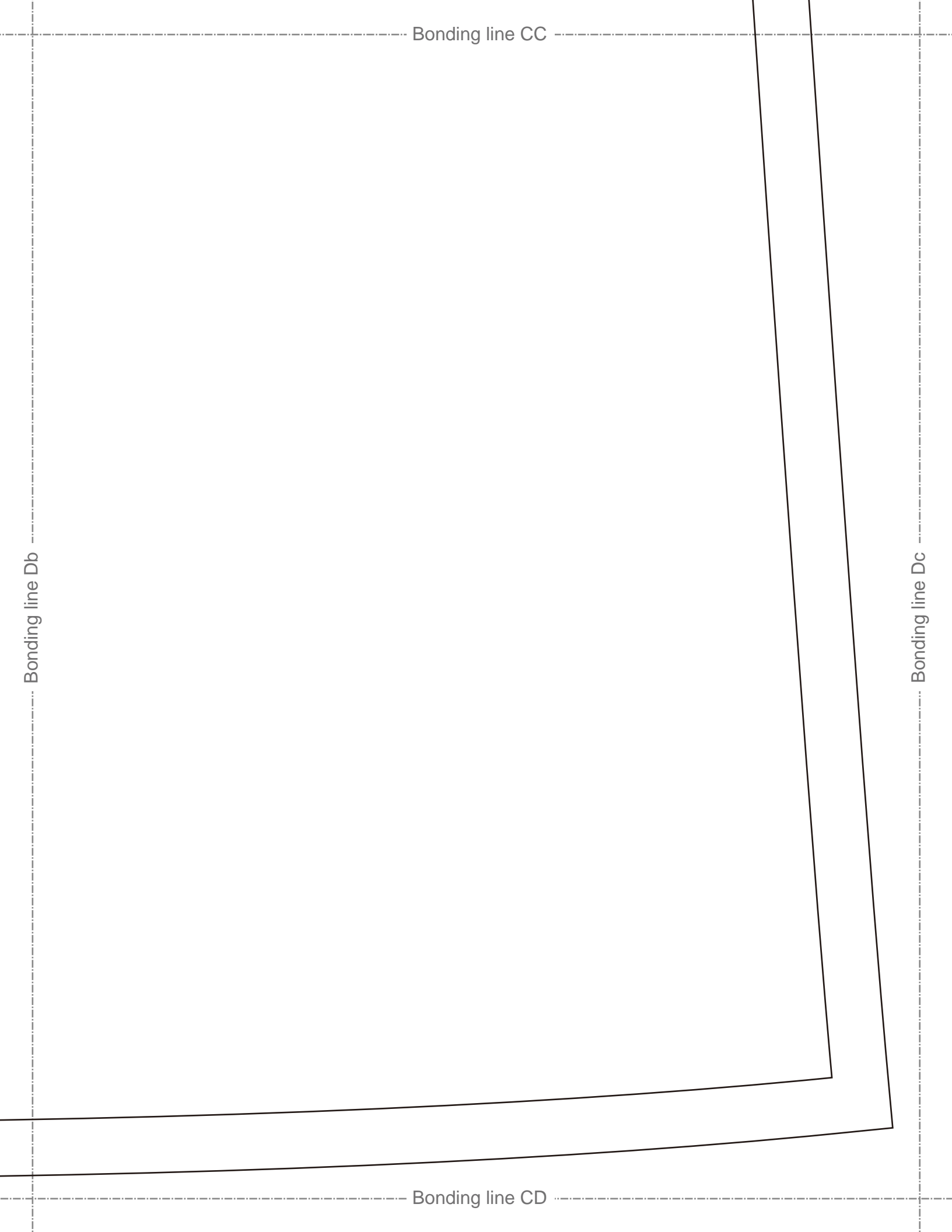



# ttndress eeve sheets

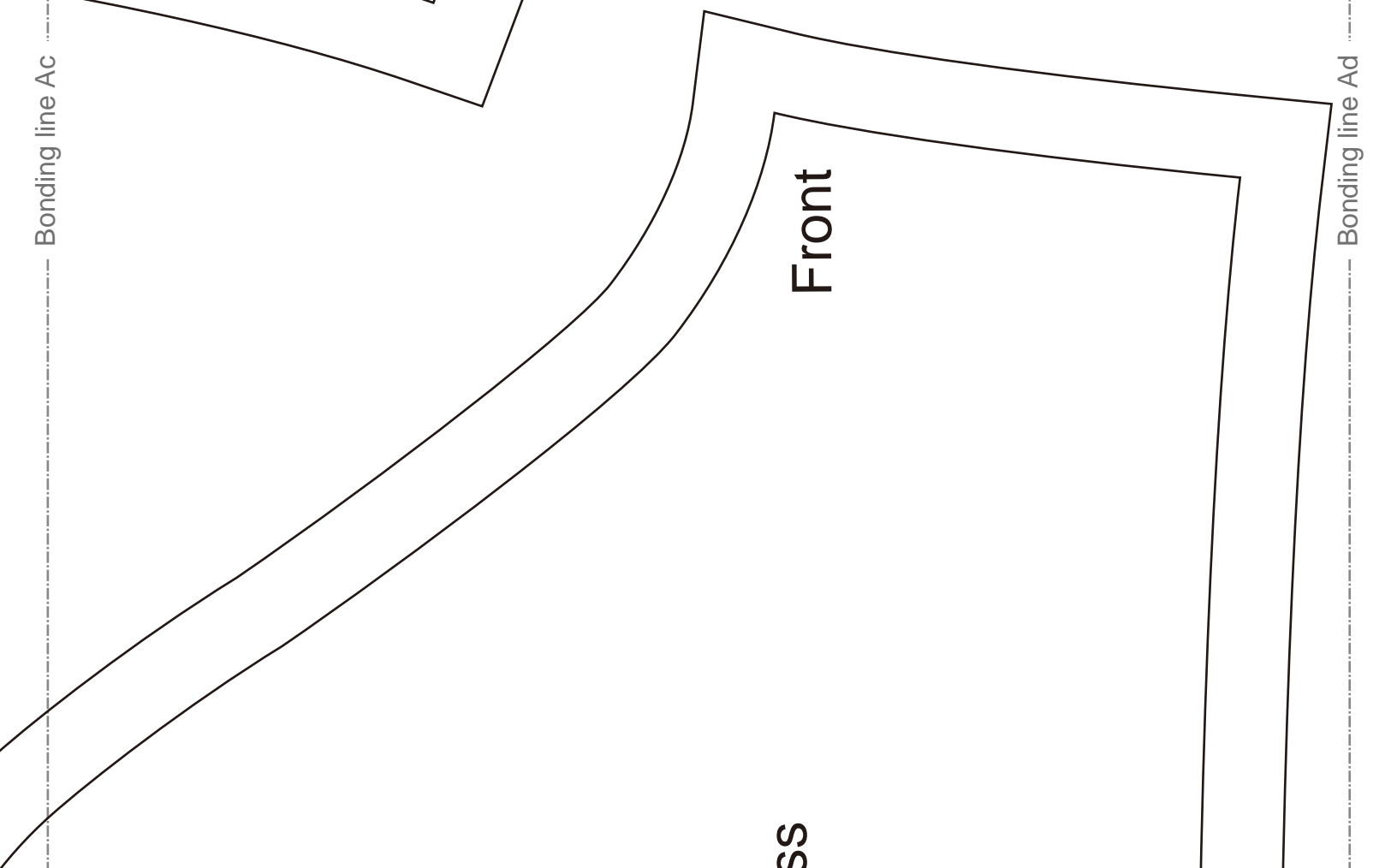

Front

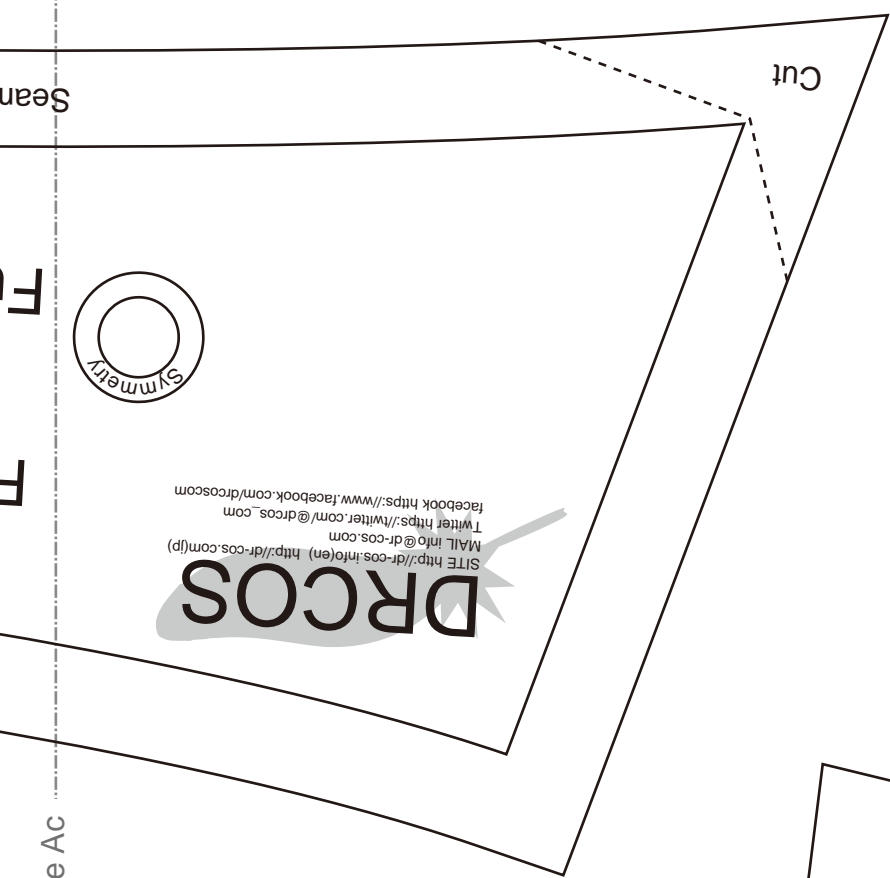

# DRCOS

MAIL [info@dr-cos.com](mailto:info@dr-cos.com) <http://dr-cos.com>  
SITE <http://dr-cos.info/en> <http://dr-cos.com/jp>  
Twitter [https://twitter.com/dr-cos\\_com](https://twitter.com/dr-cos_com)  
facebook <https://www.facebook.com/drcoscom>



Cut

Seam

Bonding line Ac

Bonding line Ad

**DRCOS**

SITE <http://dr-cos.info/en> <http://dr-cos.com/tp>  
MAIL [info@dr-cos.com](mailto:info@dr-cos.com)  
Twitter [https://twitter.com/dr-cos\\_com](https://twitter.com/dr-cos_com)  
facebook <https://www.facebook.com/drooscom>



g line D  
**Frontbutton  
Sleeve  
two shee**

Bonding line Bc

Grain Line

**Back**

Seam allowance 1/2in.

Bonding line Bd

Bonding line DB